

TECHNICAL SPECIFICATIONS & DRAWINGS

Table of Contents

Section VII-A SCOPE OF WORKS	2
Section VII-B STANDARD SPECIFICATIONS	5
Section VII-C CONSTRUCTION STANDARDS	14
Section VII-D SPECIAL REQUIREMENTS FOR EXECUTION OF WORKS	27
Section VII-E DRAWINGS AND MATERIAL LISTS	35



A handwritten signature in black ink, appearing to read "S. J. ...", is written over the right side of the NSPE logo.

Section VII-A
SCOPE OF WORKS

SCOPE OF WORKS

1.1 General

The Bidding Document covers the supply, installation/erection, commissioning, testing and handover of 0.4 kV distribution line and distribution transformers all the necessary structural, mechanical and electrical works as mentioned, specified or referred to in the technical specifications and bill of quantities.

1.1 Equipment and Materials

All equipment and materials shall be delivered by the Contractor to his designated store area and approved by the Employer or his authorized representative.

1.2 Erection

When the supply and installation of distribution system has been completed and accepted by the Employer, the Contractor will submit the inventory of erected assemblies to the Employer for approval and final payment.

Before the Taking-Over of the work, the Contractor shall clean up all areas in which he has worked, place all unused materials in the designated stores and settle any claims, which may have resulted from his work and occupancy of the area. He shall then remove all equipment, vehicles, manpower and facilities, which he has brought in, except those which may be specifically exempt by the Employer.

1.3 Scope of Work

Installation/Erection, Commissioning & Testing and Handover of 11/0.4/0.23 kV Distribution Line and distribution transformer installation in Various VDCs of Kavre district. Since this is fixed price contract and work is not limited to specified quantities specified in BOQ. Upon the arrival of materials form NEA, the work volume of individual items may be changed so as load centre. Following are the VDC form rural electrification budget head, other form the budget of NEA, will be added as per requirement of site and availability of materials.

Mahabharat & Khanikhola Ga.Pa. : Falametaar, Budhakhani Foxintaar

Namobudda Na.Pa. : Different Places (from ward 1 to 14) of Kasikhand na.pa, Kanpur, Puranagaun, Shyampati,

Roshi Ga. Pa. : Khaharepangu, Sishakhani, Bhimkhori, Sipali Chilaune, Shikhar Ambote, Mahadevtaar

1.4 Nature of Work

The scope of works under this contract shall consist of but not limited to the following:

1. Survey for line route and staking.
2. Preparation of drawings for laying out of lines.
3. Supply, installation, testing and commissioning of lines and transformers.
4. Required Conductor stringing work with all the necessary hardware and fittings.

Section VII-B

STANDARD SPECIFICATIONS



A handwritten signature in black ink, appearing to be 'S. J. Singh', is written over a light blue rectangular stamp area.

SECTION VII-B : STANDARD SPECIFICATIONS

TABLE OF CONTENTS

<u>Clause</u>	<u>Page No.</u>
1. General	7
2. Route of Circuits	7
3. Technical Documentation	7
4. Material Storage	8
5. Excavations	9
6. Pole Setting	10
7. Safety	10
8. Tests	11
9. Demolition	11
10. Cleanup	12
11. Tree Cutting and Trimming	13
12. Interruptions to Existing Service	13

1. General

- 1.1 These Standard Specifications, together with the Construction Standards, shall govern the performance of the Works and shall be the basis for inspection and acceptance of the Work by the NEA.
- 1.2 The Standard Specifications and the Construction Standards shall be considered as mutually inclusive, and the conditions stated in each shall supplement the other as appropriate.
- 1.3 All Standard Specifications shall be followed at all times by the Contractor unless specifically accepted in writing by the NEA, or unless some aspects of the work covered by these General Specifications are not required by the Scope of Work.

2. Route of Circuits

- 2.1 To the greatest extent practicable, all overhead circuits should be located along streets or travelled ways ordained by the Municipality & Village Development Committee or required authority as public property, except as required for Service drops and circuits to individual consumers.
- 2.2 To the greatest extent practicable, all facilities should be located on public property, and in no case shall private property be occupied unless specifically authorized by the NEA. The Office shall obtain any required permits for occupancy of public or private Right-of-Way.

3. Technical Documentation

- 3.1. All technical documentation as specified herein, shall be prepared by the Contractor. The Contractor shall employ skilled drafting personnel to produce all documentation specified. All technical documentation prepared by the Contractor shall be subject to the approval of the NEA prior to acceptance by the NEA of such documentation. All technical documentation shall be prepared in the English language.
- 3.2. Documentation shall be prepared using the following mediums:
 - a) Mylar material, with a minimum thickness of 0.127 millimetres, shall be used to produce the base Structure Data Sheet, As-Built Drawings and other drawings specified by the NEA.
 - b) Standard drafting vellum shall be used to produce small area plottings, profiles of line-sections and centre-line plotting necessary for the development of Structure Data Sheets and As-built Drawings.

- 3.3. Structure Data Sheets (SDS) shall be prepared in accordance with the F1 format contained in Volume 2, Section X. Structure Data Sheets shall be prepared by the Contractor showing his proposed construction details for erection of facilities in accordance with the Construction Standards. The SDS shall be prepared after the centre-line survey and staking is completed, for any line section designated by NEA, and shall be submitted to NEA for approval prior to any construction of the facilities shown in SDS. Submission of SDS for approval shall be in the form of A3 photocopy in clearly legible copy. Any unclear or illegible form entry or reproduction shall be rejected. NEA may require any revisions to be made, at their sole discretion, prior to approval of the SDS for construction. An approved and field checked SDS is required for all Construction Units invoiced by the Contractor. Field checking of the SDS shall be performed jointly by the Contractor and NEA representative. The SDS and As Built Plan are intended as permanent records for NEA. Any construction performed prior to the Contractor's receipt of approved SDS from NEA shall be completely at the Contractor's risk, and NEA shall have the right to require any correction due to the un-approved construction activities.
- 3.4. As-Built Drawings shall be prepared by the Contractor in the general format provided by the NEA. Drawing size shall be approximately 841 x 597 mm overall and the scale shall be 1:10,000, 1:2,000. The NEA shall provide any available environmental background data for inclusion on the various drawings and the Contractor shall record (in ink) all facilities as-built.
- 3.5. The Contractor shall prepare other technical drawings, in the same medium and format as the As-Built Drawings, for As-Built Drawings index sheets, pole maps, and One-Line Diagrams as specified and required by the NEA.
- 3.6. The Contractor shall and prepare and furnish Transformer Record documents, in the format specified by the NEA, for each transformer installed.

4. Material Storage

- 4.1. The Contractor shall procure all materials and equipment for the work. The Contractor shall provide all labour, equipment, and vehicles to load and transport said materials and equipment to the Contractor storage facilities and worksites as required. All materials and equipment turned in to the NEA reclaimed after demolition of existing facilities if any shall be transported to the NEA warehouse and unloaded in the same manner.

4.2. Worksite

- a) Extended storage of materials along the routes of lines will not be permitted. All small items of material shall be provided to the work crews on a daily basis and no small items of materials may be stored on the worksite overnight.
- b) ABC cable and conductor reels may be spotted at the worksites for a short period prior to installation provided that crating and reel lagging are intact to protect the items. Poles may be spotted at structure locations for short periods prior to setting.

- c) All poles, ACSR conductor , ABC cable placed at the worksites shall be located so that the items are not subject to damage and do not impede pedestrian or vehicular traffic.
- d) Any damage caused by imprudent placement of equipment and materials by the Contractor at the worksites shall be corrected by the Contractor, in a manner acceptable to the NEA, at the Contractor's cost.

4.3. Contractor Storage Facility

- a) The Contractor shall be financially responsible for the secure and proper storage of materials to prevent loss or damage to any materials.
- b) Any items of material and equipment contained in degradable packaging shall be stored under roof and protected from moisture. Other materials, except as specified in subparagraph (c) below shall be stored and covered in a well-drained level area, free from accumulation of surface water.
- c) Transformers, disconnecting switches, and reels of ABC cable may be stored outdoors in a well-drained, level area free from accumulation of surface water. Reels of ABC cable may be stacked on reel sides not more than three (3) reels high. ABC cable reels shall be placed on Wood pallets, wood lagging, or well-gravelled level surface.
- d) Packaged items of material and equipment shall not be uncrated, or have packaging removed, prior to installation. The Contractor shall exercise due caution and care in the transportation, storage, and handling of all materials which are to be provided by the NEA. Equipment consisting of, or containing, porcelain insulation should be transported and handled to avoid cracks or chipping. Lagging or other protection, shall not be removed from ABC cable reels until the cable is to be installed.
- e) The ends of installed cables shall be sealed immediately after being cut with a non-absorbent covering fastened around the outer jacket.

5. Excavations

- 5.1. All excavations made for the installation, or demolition, of facilities shall be accomplished in a timely manner according to the scheduled installation. Required excavations shall be opened, material installed, and backfill placed, as specified, in a continuing operation to the greatest extent practicable.
- 5.2. Any excavation left open during discontinuous construction which is accessible to the public or along public thoroughfare, shall be covered or barricaded, and marked by suitable visual means, to prevent a public hazard.

- 5.3. Excavations shall be properly located and sized for the intended use. Pole and stay plate/ anchor excavations shall be correctly sized to retain undisturbed soil to the greatest extent consistent with the means of excavation. Pole holes shall be made by power-driven auger or by manual methods; power-driven shovel equipment shall not be used. Pole holes shall be excavated to the specified depth with no tolerance shallow and tolerance of ten (10) centimeters deep. The bottom of pole holes shall be undisturbed soil, gravel or rock. Stay plate holes shall be excavated by manual methods to specified depth with no disturbed soil in the direction of the anchor rod.
- 5.4. All excavations shall be backfilled with excavated material, or as specified for the installation. Backfill shall be free of foreign materials and shall be well tamped with excess backfill graded over the excavated area to prevent depressions resulting from eventual natural compaction. Large amounts of excess backfill shall be removed from the site by the Contractor if so directed by employer. If so directed by NEA, The Contractor shall provide suitable backfill materials for excavations where existing removed materials is insufficient, or inappropriate, to provide suitable grading of the excavated area.

6. Pole Setting

- 6.1 Poles shall be set in accordance with the appropriate Sections of the Construction Standards and subparagraph 6 above.
- 6.2 Each pole shall be assigned a unique construction number at the time of structure staking for preliminary identification and preparation of structure Data Sheets (SDS).
- 6.3 Subsequent to the preparation and approval of SDS, and prior to provisional acceptance of a given line section, the NEA shall provide the Contractor with unique permanent pole numbers. The Contractor shall then apply the specified permanent pole numbers to each pole with black oil-based paint in neat clear English letters and/or Arabic numerals. Permanent pole numbers shall be applied in letters/numerals five (5) centimetres in height at a point on the pole 1.6 meters above ground level. Numbers shall be applied on the side of the pole facing the adjacent street or travelled way.

7. Safety

- 7.1 The Contractor shall take all measures required to safeguard the public, public and private property from any hazard to life, limb, or property which may arise during the performance of the construction of the works. Such measures shall include, but not be limited to: barricades, signs, newspaper announcements, traffic control by police, or other advisory and control methods deemed appropriate.
- 7.2 The Contractor shall provide his work force with all tools and equipment in sufficient numbers and quality to perform all aspects of the works in a safe manner. The Contractor shall provide protective headgear for all members of his workforce, and shall provide

protective clothing as required for specific tasks. The Contractor shall instruct his work force in proper and safe construction techniques and shall continuously monitor compliance with safety instructions throughout the period of the Contract.

- 7.3 The Contractor shall provide, and require use of, protective grounding equipment when:
- a) Work is being performed on lines adjacent, either in extension of, or parallel to, energized circuits.
 - b) Work is being performed on isolated circuits after conductors have been installed.
- 7.4 The Contractor shall maintain all tools and equipment in good working order. All mechanized equipment shall have adequate safety mechanisms and guards in place and be fully operational. Operators of such equipment shall be skilled and fully trained in the operation of such equipment.
- 7.5 The Contractor shall provide and maintain emergency medical supplies to cover with accidents and snakebites for his work force on a readily available basis. The Contractor shall also instruct all supervisory personnel in the action to be taken in the event of serious injury, and the sources and locations of professional medical assistance which shall be employed in such cases.
- 7.6 The Contractor shall apply all accidental insurance policies to his work force for an accident occurring during the working period of the construction.

8. Tests

- 8.1 The Contractor shall furnish the electrical test equipment and personnel to perform electrical tests of equipment and circuits, as specified by, and under the supervision of the NEA.
- 8.2 The Contractor shall megger all circuits installed with a motor-driven megger or equivalent instrument to demonstrate the acceptable insulation characteristics of the line prior to energization and Provisional Acceptance.
- 8.3 The Contractor shall megger all transformers with a motor-driven megger prior to installation
- 8.4 All tests specified shall be conducted during suitable atmospheric conditions under the supervision and witness of the NEA. All test results shall be documented and signed by both parties.

9. Demolition

- 9.1 The Contractor shall perform the removal of all existing facilities, if any, in accordance with the specific directions of the Employer. All materials removed shall remain the property of NEA and the Contractor shall deliver all salvaged materials to the NEA warehouse, or as specifically directed by the Employer.
- 9.2 All poles shall be removed by pulling the complete pole from the ground; poles shall not be cut off at the ground line. Holes shall be backfilled and compacted completely with sufficient added backfill piled above grade to prevent depressions being created by natural compaction. Backfill material shall be provided by the Contractor.
- 9.3 All conductor materials removed shall be returned to the NEA. Methods of conductor removal shall be specified by the NEA. If conductor is removed in the longest length practicable for future re-use, the said conductor shall be wound on empty conductor reels, with the reels marked with the conductor size and approximate length. Different conductor sizes shall not be mixed on any reel. If conductor is removed from structures and specified as scrap, conductors may be cut down in lengths and made up in rolls. Conductor sizes for scrapping may be mixed; different conductor metals shall be separated.
- 9.4 Care shall be taken in removing, handling, and transporting cutouts, and surge arresters to minimize porcelain damage.
- 9.5 Transformers removed from service shall be delivered to the NEA warehouse or as specifically directed by the Employer. Care shall be taken in removing, lifting, and transporting transformers.
- 9.6 Other structures shall be removed, such as concrete transformer pedestals in the most appropriate manner, as specified by the NEA. Existing stay rods may be cut 20 centimetres below finished ground level.

10. Cleanup

- 10.1 The Contractor shall ensure that all worksites shall be free of all manner of debris resulting from the construction activity.
- 10.2 All crating, ABC cable and conductor reels, packaging materials, conductor scraps, and other miscellaneous items are removed from the workplace. All holes resulting from removal of facilities shall be filled. If trees or bush have been cut or trimmed, all cuttings shall be removed. The worksites shall be left in clean natural conditions.
- 10.3 Site cleanup shall be an integral part of the Provisional Acceptance process, and no line section shall be provisionally accepted unless all clean-up work has been accomplished.

11. Tree Cutting and Trimming

- 11.1 Any tree cutting or tree trimming authorized and directed shall be accomplished by the Contractor under the direct supervision of NEA.
- 11.2 All cutting shall be removed by the Contractor with disposition of cutting as specified by NEA.

12. Interruptions to Existing Service

- 12.1 The Contractor shall arrange for interruptions of service to existing lines with NEA. Every effort shall be made to limit such interruptions to the minimum.
- 12.2 If it is possible to maintain service to a section of line by constructing temporary facilities approved by NEA, the Contractor shall detail man hours and classification of personnel required to construct such facilities and submit to NEA for approval prior to any work being performed. Payment for approved work shall be based on the rates covered in Construction Unit LR of Section VIII, Volume 2.

Section VII-C

CONSTRUCTION STANDARDS

CONSTRUCTION STANDARDS

1.0 GENERAL INSTRUCTIONS	16
A. <i>General</i>	16
B. <i>Pole numbering</i>	16
2.0 POLES, CROSSARMS, AND STAYS	17
A. <i>Poles</i>	17
B. <i>Pole setting</i>	17
C. <i>Pole Framing</i>	17
D. <i>Stays</i>	18
E. <i>Stay Insulators</i>	18
F. <i>Field Modifications</i>	18
3.0 CONDUCTOR	19
A. <i>Materials</i>	19
B. <i>Sagging</i>	19
C. <i>Sag Charts</i>	19
D. <i>Stringing</i>	20
E. <i>Damaged Conductor</i>	20
F. <i>Sag Error</i>	21
G. <i>Conductor Attachment</i>	21
H. <i>Line Splices For Tensioning And Looping</i>	21
I. <i>Connectors</i>	21
4.0 CONDUCTOR ACCESSORIES	23
A. <i>Pre-Formed Ties and Grips</i>	23
B. <i>Preformed ties for Stay Wire</i>	23
C. <i>Application</i>	23
5.0 LINE CONSTRUCTION	24
A. <i>Arrangement of Conductor</i>	24
B. <i>Attachments To Poles</i>	24
C. <i>Conductor Ties</i>	24
D. <i>Conductor Support</i>	24
E. <i>Pole Wiring</i>	24
6.0 INSTALLATION OF STAYS	25
7.0 INSTALLATION CRITERIA	26

1.0 GENERAL INSTRUCTIONS

A. General

The general instructions included in this section shall be applied to all 11 kV and 400/230 volt overhead line construction under this NEA. Additional general instructions are included in each section as they are applied specifically to the subject covered in that section.

These construction standards provide basic requirements for new facilities.

The clearances of conductors and structures shall be as per the construction standard drawing no. CSG-01, CSG-02 and CSG-03.

Deviations from these standards may become necessary due to unique or special conditions. In such cases, the directions of the Employer shall be followed.

The safety rules of the NEA shall be strictly observed at all times by the Contractors' and NEA's work forces.

B. Pole numbering

Poles and structures shall be numbered in accordance with a numbering system provided by NEA. Each pole or structure shall be paint stencilled with the assigned number.

2.0 POLES, CROSSARMS, AND STAYS

A. Poles

Poles shall be installed by length and class at locations in accordance with the construction plan.

B. Pole setting

Pole holes shall be dug large enough in diameter to admit a tamping bar all around the periphery of the pole and shall have a uniform dimension as per the type of pole used at the top and bottom. Poles shall be planted in the ground to the depth specified in Table 2. Before planting a pole, the bottom of the hole made for planting the pole, shall be cleaned of free soil and firmly tamped, to prevent the hole from settling.

The stability of a pole, particularly a pole without stay, is greatly influenced by the size of the pole hole, the nature of the soil and the care exercised in back filling and tamping. Two active hand tampers and one slow shoveler shall result in good compaction.

Poles shall be set to stand perpendicular except at terminals, angles and other points of excessive strain where they shall be given a rake not to exceed 10 centimetres against the direction of strain. Poles located at the sides of banks or other locations, where washouts may occur, shall be protected by suitable cribbing, or shall be referred to the Engineer for recommended action.

After the pole is in position and the hole is back filled and tamped, soil shall be piled and packed firmly around the pole. Pole setting shall be inspected prior to acceptance and any back fills that have sunk shall be refilled.

Poles located in shallow river beds shall be protected by gabions as designated by the Employer. Gabions should be approximately 2 metres x 1 metre x metre. Four such gabions are required for each pole.

Set pole and pour 860 mm diameter foundation and level areas around pole and set gabions in pattern shown in CSG-06. It is important to lace adjacent gabions together along the perimeter of all contact surfaces. Fill gabions with hard, durable, clean stone, 100 mm to 200 mm in size in three layers. Install two connecting wires at each layer. Lace gabion lids securely and make certain that all edges are closed. Fill void between pole and gabion with hard, durable, clean rock 200 mm minimum size.

C. Pole Framing

Pole and structures shall generally be framed in accordance with these standards and the construction structure data sheets. Where special framing requirements are necessary, the Employer shall provide framing instructions for the specific structure.

Each cross-arm shall be attached to the pole by a pole clamp or by machined bolts of sufficient length to pass completely through the holes provided on the pole and cross-arms and receive their full complement of nuts.

Bolts of proper length shall be used. Excess nuts shall not be used to make use of a bolt which would otherwise be too long. The end of a machined bolt NEAing more than 3 centimetres beyond the nut shall be cut off to a length of 2 centimetres beyond the nut. Each bolt, when installed, shall have its full complement of nuts.

D. Stays

Stay leads specified in construction documents are defined as the horizontal distance from the centre line of the pole at ground line to the point where the anchor rod should enter the ground assuming the ground to be level. For the correction in stay leads for uneven ground see Drawing No. CSG-11.

The Engineer, upon request, may designate the actual location of stay anchor rods on slope of hills. The stay stake indicates the point where the anchor rod enters the ground. The anchor hole shall be dug accordingly.

The attachment of one stay shall not overlap that of another stay when two or more stays are carried to a pole or anchor. Each shall be entirely independent of the other. This does not prevent the use of multiple eye rods for nuts designed for such use.

All stays to be installed on a pole line shall be placed and drawn reasonably tight before the conductors are tensioned. After the conductors are tensioned and sagged to their final position, the stays shall be carefully inspected to see that each is carrying its share of the load on the pole as intended. If multiple stays are not carrying equal strain, the slack stay shall be pulled up until it is sharing load as intended.

Stay anchors must be installed full depth and set to pull against undisturbed soil to develop full tension. An anchor not properly installed will move and allow movement of the top of the pole, thus slacking the conductors. Stay anchors installed in soft or unstable earth shall be placed at specified depth and back filled with 5 cm. maximum size crushed stone placed to a depth of 1 meter from the bottom of the pole.

E. Stay Insulators

Stay insulators shall be installed on all stays in accordance with the construction drawings.

F. Field Modifications

During the erection work at the field there may be necessity to modify galvanised steel hardware and may have to be drilled, reamed, filed or cut. Under such a condition the area of the steel exposed, after these modifications, shall be coated with a zinc-rich paint to protect the steel from corrosion.

3.0 CONDUCTOR

A. Materials

XLPE covered conductors refer to an assembly of strands of hard drawn aluminium alloy for greater strength which are termed as All Aluminium Alloy Conductor (AAAC) Conductor.

B. Sagging

Conductors shall be sagged in accordance with the sag chart specified by these specifications.

The importance of careful sagging of conductors cannot be over emphasised. Conductors have definite characteristic that control their behaviour resulting from changes of temperature, wind speed and additional load due to ice or wet snow.

Conductors must not be sagged too tightly (less than specified sag) as unspecified extra tensions may result in failure of conductor structure.

Conductors sagged too loosely (more than specified sag) may contact adjacent conductors hardware or any structure. Excess sag can reduce clearance beneath the line with the ground to the point of danger.

C. Sag Charts

Unless otherwise noted, all sag charts are calculated on the basis of 35 kg/sqm wind pressure

Sag is always measured vertically, without wind, when conductors are being installed or re-sagged.

Unless otherwise specified by the Employer for a specific condition, initial or stringing sag shall be applied to the installation of all new unstressed conductor. The initial sag is always less than the final sag.

Sags for the various temperatures shall be furnished by the Engineer in a table form for spans not covered by the sag chart.

In order to ascertain the sag for a given stringing temperature, select the point corresponding to the proper temperature on the scale on the left-hand side of the sag chart. Lay a straight edge so that it passes through this point and the point of the centre scale representing the length of span to be sagged. The straight edge will then indicate the proper stringing sag on the right-hand scale. Interpolate if the temperature of span is not exactly the same as designated on the chart. The low voltage neutral conductor shall be sagged with the same sag as the low voltage phase conductor. If the low voltage conductor, as a group, has less design sag than the high voltage phase conductor

installed above it, the low voltage conductor, as a group, shall be installed to the same sag as the high voltage conductors installed above.

D. Stringing

The dynamometers and similar apparatus shall be used for tensioning of conductor to obtain appropriate sagging of conductors.

For stringing of XLPE Covered (AAAC) Conductors of all sizes, stringing rollers or roller shall be used to support the conductor as it is pulled out and sagged. Stringing rollers shall be used regardless of size of aluminium conductors, bare or covered.

Stringing rollers shall be suspended at each insulator support position so that the conductor shall roll smoothly over the roller protecting conductor from any physical damage.

Stringing sheaves shall have a diameter at least 20 times the conductor diameter and so finished as to prevent damage of any kind to the conductor as it is pulled through the sheaves.

Conductor drum shall be located at a sufficient distance from the first structure to avoid excessive bending of the conductor over the sheaves and excessive downward loading on the cross-arms.

Attention shall be paid to the fact that all sag charts contained herein for AAAC conductors are calculated on the basis of non pre-stressed conductor. For this reason, at no time during the stringing or sagging operation, shall conductors of this type be pulled to sags which are less than those shown by the charts.

Special care shall be taken at all times to prevent the conductor from becoming kinked, twisted or abraded in any manner. Where it is necessary to drag conductors on the ground, the conductors shall be protected by covering all stones or other objects which might damage the conductor with boughs or trees or suitable pieces of lumber. These requirements are specially important when AAAC conductor is being handled on river crossing spans. Floats with rollers shall be used to prevent the conductor from dragging along the river bottom.

In stringing conductors across highways, the conductors shall be fully protected from passing vehicles by use of temporary guard structures.

E. Damaged Conductor

Damaged conductors shall be repaired by using a repair sleeve provided that no more than 2 strands of the outer aluminium layer are damaged and further provided that none of the sleeve core strands are damaged. For a conductor damaged in excess of the above conditions, the damaged section of the conductor shall be cut out and a tension splice installed.

When cutting out damaged section of conductor, no more than 1 tension splice shall be permitted in a span and no splice be made within 8 meters of an insulator attachment.

F. Sag Error

Sag error shall not exceed ± 40 mm from the sag defined by the sag chart.

G. Conductor Attachment

Conductors shall be secured to pin insulators with pre-formed conductor ties or with tie wire. Insulator ties, except at jumper supports in structures, shall be made with pre-formed ties when available.

Conductors shall be connected to dead end assemblies with tension set.

H. Line Splices For Tensioning And Looping

Cleaned and polished contact surfaces are necessary to make conductor splices so that it shall remain free from trouble. Great care shall be taken to completely clean the strands of aluminium conductor. The splicing sleeve must be centred over the conductor ends before compressing to make a splice of required strength.

The outer strands of aluminium shall be carefully cleaned with a wire brush to remove all foreign matter till the aluminium shines brightly. The cleaning applies to both new and old conductors. Splicing sleeves for aluminium conductor are supplied by the manufacturer pre-filled with inhibitor compound.

Splices in line conductors shall be so located that the end of the splicing sleeve is at least 30 cm from the end of a suspension or dead end clamp. Non-tension loops, such as between dead ends, shall be spliced with a connector when the conductor are of same metal and size.

I. Connectors

1. Cleaned and polished contact surfaces are necessary to make electrical connections that will be free from trouble.
2. Tap connectors are supplied by manufacturers pre-filled with inhibitor compound. Excess inhibitor compound shall not to be removed but it shall be wiped over the connector as a moisture seal. Connectors shall not be covered or taped.
3. Compression connectors shall be located in such a manner that there shall be at least 30 cm of conductor between the end of the connector and the end of a dead end
4. Connectors shall be installed on non-tensioned portion of the conductor such as loops in preference to the conductor in the span.

5. Connectors installed on conductor shall be located in a span adjacent to the crossing rather than the crossing span when practicable.
6. Aluminium compression connectors, pre-filled with inhibitor compound, shall be compressed on the cleaned area of aluminium conductor. Where necessary, inhibitor compound shall be applied to the cleaned conductor and connector before assembly.
7. Aluminium compression connectors shall be used for connecting aluminium to aluminium conductors.

4.0 CONDUCTOR ACCESSORIES

A. Pre-Formed Ties and Grips

Taps for jumpers and services shall not be made over the legs of ties or dead end grips.

B. Preformed ties for Stay Wire

Preformed ties for stay wire are furnished as per material list CSG-29, 30.

Preformed ties for stay wire are right hand lay. Preformed ties for stay wire may be removed and replaced up to 3 times, when initially installed, to permit adjustment of stay tension.

C. Application

When applying ties or grips the manufacturer's identification tag and colour coding shall be checked to insure that the tie or grip is the right unit specified for application on the specific conductor or wire strand.

Preformed ties for stay wire are furnished with two crossover markings. When applying preformed ties on hardware, the grip shall be installed using the crossover point closest to the loop of the grip.

5.0 LINE CONSTRUCTION

A. Arrangement of Conductor

The standard position of 11 kV phase conductors on the cross-arm in the normal triangular configuration looking from the normal source of power supply shall be seen as:

Red (R) on top of the pole, Yellow (Y) on right hand end of the cross-arm and Blue (B) on left hand end of the cross arm.

B. Attachments To Poles

Bolt holes are provided on poles for cross-arms, cross-arm braces and stay bolts.

C. Conductor Ties

Pre-formed ties and grips shall be used for attaching conductors to structures when available.

If pre-formed materials are not available, the wire shall be soft conductor so that when made up, the tie wire will bind the conductor tightly. No tie wire shall be used for a second time.

Jumpers on structures shall always be made with tie wire as per Drawing No. CSG-29

Tie wire shall be of the same metal as that of the bare conductor to which the tie is applied.

D. Conductor Support

The conductor supports on straight lines shall be carried on the top wire groove of the pin insulator. Conductors shall be attached to the side conductor groove of pin insulator on the outside of angles so that transverse conductor tension will tend to hold the conductor in the insulator groove.

Conductor ties shall not hold a conductor on the insulator when uplift exists. If uplift is found, it is required to consult with the Employer to determine remedial action to be taken.

E. Pole Wiring

All taps or connections passing from one level to another on the pole shall, as far as possible, be vertical. Connections shall have sufficient length so that the line conductors are not moved from normal positions and normal movement is not restricted. Connections shall have at least 30 centimetres clearance from other conductors. Any connection carried from one side of the pole to the other side shall be supported on pin insulators.

6.0 INSTALLATION OF STAYS

1. Where stays are installed on a line angle structure, line of stay shall bisect the outside line angle.
2. The span of stay extending between poles shall not be greater than 50 meter.
3. Anchor and anchor rods shall be set so that the axis of the rod and line of stay shall be straight. The portion of the anchor rod above the ground shall not be bent at an angle to connect a stay wire. If this occurs, anchor and anchor rod shall be reset. The anchor rod shall not be exposed for more than 15 centimetres above the ground after the anchor is set.
4. If gravel back fill is required to set anchor in soft or unstable soil, as per Drawing No. CSG-07, gravel back fill shall be designated as "Local Material".
5. If a stay is installed on a pole where low volt conductor is dead ended or double dead ended and extends past stay, a piece of plastic hose slit along the length shall be placed over the stay wire extending from the upper stay attachment to 200 mm below lowest low voltage conductor. After installation, the hose shall be wrapped with plastic tape and the hose shall be secured to the upper stay bolt with tie wire. Plastic hose shall be "Local Material".
6. The successful Bidder shall make preliminary survey of the work site to finalize the type of poles being used. The size / type and quantity of pole clamps may subject to variations as per fiend requirements.

7.0 INSTALLATION CRITERIA

GENERAL INSTRUCTION

1. The line alignment should be as straight as possible to minimise requirements for stays.
2. The basic span shall be maintained within the following limits:-
 - a) For 11 kV: 50 m to 70 m
 - b) For 400 V and 230 V: 40 m to 55 m
3. The entire construction works shall be performed as per the construction units specified. Whenever the construction unit does not cover any specific activity, the Contractor and the NEA shall mutually settle the cost as per the man-hour involvement for the same and according to the labour rate quoted by the Contractor in his Bid.
4. Detailed schedules of material to be used are provided in each structure drawing of the construction standards. It shall be the responsibility of the Contractor to judge the appropriateness of the listed material according to the site conditions. If there is any need for addition/reduction or deviation from the listed material size/quantity, the Contractor shall ask the NEA for the approval of the same.
5. All types of line clearances shall be maintained as per the construction standards provided to the Contractor. Deviations from the standards may be allowed only for unique or special conditions.
6. Safety rules of the NEA shall be strictly observed at all times by the NEA, Contractor and their personnel. Special care shall be taken to maintain the optimum conductor sag to provide adequate safety to the construction and the property or people.
7. All fastenings (e.g. preformed ties, nut bolts, stays etc.) shall be so installed that the constructed line components shall not fail to remain within the safety margin while maximum working load is applied.
8. If the Contractor requires clarification of any construction standard or unit or he feels any doubt in his interpretation of construction activities he should clarify the points with the NEA in writing and the decision thus made shall be valid for further work.
9. Stays:- The Contractor, in general case, shall install at least one stay for the supports in the following cases:
 1. Dead end structure
 2. Tee-off (Tap) structure

Section VII-D

SPECIAL REQUIREMENTS FOR EXECUTION OF WORKS

SECTION VII-D

SPECIAL REQUIREMENTS FOR EXECUTION OF WORKS

TABLE OF CONTENTS

1. Site Office Management	29
2. Contractor's key personnel and workforce	29
3. Tools and Equipment	30
4. Approval of Drawings	30
5. Extra Work	30
6. Materials	31
7. Local Materials	32
8. Construction Time Schedule	32
9. Measurement of work and material	32
10. Workmanship and quality of work	33
11. Commissioning of work	34

1. Site Office Management

- 1.1 The contractor and / or sub contractors as proposed by the bidder as per GCC shall establish and maintain throughout the period of the performance of the contract a site office to serve as a base for all the operations necessary to perform the works and shall maintain adequate store facilities for storing materials and equipment issued by the employer. In case the above-mentioned facilities and establishments are not found satisfactory during the site verification, the employer shall have right to instruct the contractor for rectification of the same.
- 1.2 Prior to the beginning of construction works the contractor at his own cost shall establish a demonstration and training installation of 11/0.4 kV structures as listed in construction standards of tender document. The installation shall include at least 3 spans of AAAC conductor and ABC cable of each size to illustrate the type of materials used for tangent, angle and dead end construction for 11/0.4 kV line. Such structures need not be spaced more than 10 meters apart. The intent of establishing such arrangement shall be to provide visible examples of the application of the various materials to be used and to provide training and testing facility for the contractor's line construction personnel.

2. Contractor's key personnel and workforce

- 2.1 The contractor shall have experienced and qualified administrative, accounting and store keeping staffs capable to undertake respective jobs. An office manager with adequate qualification and experience to run such establishment efficiently must head the site office. The contractor shall employ only experienced, competent and skilled office staff as required in the tender document.
- 2.2 The line construction and supervisory staff of the contractor shall be examined by the employer to ensure their capability to perform proper quality of work as per Evaluation Criteria (Section 3) clause no. 2.5 before commencement of the work.
- 2.3 The site and field staff as approved by the employer shall be made available for the entire construction period of the NEA. All the staff and workforce of the contractor shall be issued identity cards jointly certified by the contractor and the employer. Replacement of any such staff or site personnel must not be made without prior permission of the employer.
- 2.4 The contractor is required to pay salary and wages of his staff and workforce at an interval not exceeding a month. The rate of wages payable to the labours shall not be less than as prescribed by the labour law of Nepal.

3. Tools and Equipment

- 3.1 The Contractor shall have owned, leased or hired tools and equipment for successful execution of the work. Prior to beginning of the work the contractor shall show these items in his possession. In case of the heavy tools equipment and vehicles the contractor is required to submit the source of these items with credible documents such as contract papers conforming their availability at the time of the execution of the works.
- 3.2 The employer shall examine to verify the availability of all such tools and equipment before commencement of the work. The contractor shall be allowed to start his work only after verification of such tools and equipment in satisfaction of the employer. No tools and equipment shall be provided by employer.

The contractor shall have following tools and equipment for the execution of the contract:

S.N.	Description of Tools and Equipment	Unit	Quantity
3	Max or Ratchet Puller suitable for HV/LV Cable Tensioning	Nos.	3
4	Come along Clamp suitable for HV/LV Cable Tensioning	No.	3
5	Crimping Device for jointing Cables	Nos.	2

4. Approval of Drawings

- 4.1 The contractor shall update and revise all plan and profile drawings provided to him by the employer after performing check survey of each of the segment of the scheme.
- 4.2 The contractor must get approval from the employer in writing before he starts execution of construction of any of the segment of work. If the contractor executes any work without the employer's prior approval, he may be asked to revise the same without paying any compensation to him.

5. Extra Work

- 5.1 Extra work and goods supply shall be performed in accordance with written directives as issued by the NEA to the Contractor.
- 5.2 Extra work or goods supply for which there are applicable unit prices will be paid for at such unit prices.
- 5.3 Where there are no applicable contract unit prices, the price to be paid by the NEA to the Contractor for extra works / goods supply shall be fixed through negotiation between Employer and the Contractor based on:

- the GoN norms and respective district rate approved by the District Rate Fixation Committee in case of extra works to be performed
- the prevailing market rate of the goods, in case of extra goods to be supplied.

In no case, such price shall exceed NEA's cost estimates for the item.

- 5.4 Nothing in this Clause shall excuse the Contractor from proceeding with the extra work as directed in writing by the NEA.
- 5.5 Any variation in the quantities of unit price construction units, within the ranges stated in the Special Conditions of Contract, Clause 1.3, from nominal bid quantities of such unit price construction units shall not be construed as Extra Work.

6. Materials

- 6.1 All the construction materials for installation of the Works shall be provided by the NEA.
- 6.2 All materials and equipment of the NEA shall be located at the NEA's or such other areas where they are being stored. During issue and handling over of these materials it shall be the Contractor's responsibility to load all of them and provide all necessary lifting and handling equipment, labour and suitable transport as required to transport the various items of materials and equipment to the Contractor's site of storage and operations.
- 6.3 The listing of materials shall show the limiting allowance for breakage and scrap and material unit prices, which may be applied to the contractor's accountability to the NEA for all materials and equipment issued by the NEA. Allowances for such materials shall be as under:
- | | |
|--------------|-------|
| - ABC Cables | 0.5 % |
|--------------|-------|
- 6.4 Accountability for all materials and equipment issued by the NEA shall be based on the material lists associated with the various construction drawings contained in the Construction Standards and the allowances referenced in clause 3 above. At the time of final material accounting, any deficit in the Contractor's material account shall be charged to the Contractor at the unit price rates enlisted by the NEA during handing over of the materials to the Contractor.
- 6.5 If the Contractor fails to account for all materials and equipment issued by the NEA as set forth in clause 4 above, the Contractor shall be charged for the missing materials or equipment. The NEA shall have the right to withhold money due or to become due to the Contractor, as reimbursement for the deficit in the Contractor's material.
- 6.6 Prior to the rehabilitation work, representative of the NEA's local branch office the Site Engineer and the contractor shall jointly inspect the materials to be dismantled and list down such materials. It shall be the contractor's responsibility to pack those goods

appropriately, transport them to the nearest NEA store and get receipt. Such receipts shall be enclosed with the subsequent invoices claimed by the contractor.

7. Local Materials

- 7.1 Certain minor items of materials, including civil materials, required by the Construction Standards are designated Local Materials in the Standards and shall be furnished and installed by the Contractor as part of the completed unit of construction.
- 7.2 The contractor shall include the cost of such items of materials in his quoted construction unit prices and no other payments for such materials shall be made to the contractor.
- 7.3 The NEA, may, at its option, require the NEA's approval of any or all Local Materials prior to procurement of such items by the Contractor.
- 7.4 It shall be the Contractor's responsibility to determine his requirements for any items of Local Material in a timely manner and make procurement accordingly. No delays shall be allowed, and no exceptions made to the required use of Local Materials due to the unavailability of such materials.

8. Construction Time Schedule

- 8.1 Before the commencement of construction works the contractor shall be required to submit a detail construction time schedule showing details of each event of construction of different components of works so as to complete the whole work within the time frame as per the requirement of the contract. The contractor's proposal shall be examined by the employer to ensure his ability to perform the work in time and approval shall be given with any modification, if necessary, in satisfaction of the employer.
- 8.2 If the contractor fails to execute the any component of work within the period specified in the construction schedule, the employer shall have right to warn the contractor to make up for such delay in time. In case the contractor fails to overcome delay in different components of the works instead of repeated reminders by the employer, he shall be made fully responsible for any delay in final time schedule and no consideration shall be made for any extension of construction period for the whole work.

9. Measurement of work and material

- 9.1 The contractor after completion of work of any segment of work as per approved drawing of the NEA shall submit detail work measurement in structure data sheet (SDS) as per the format Sheet-1 in this section of the tender document.

- 9.2 Measurement of the work performed by the contractor shall be jointly checked by the contractor and the staff deputed by the employer. In case of any discrepancy or dissatisfaction of employer staff the contractor shall be notified for making corrections for the same and the contractor shall have to submit his revised measurement schedule.
- 9.3 The contractor shall be issued materials based upon the requirements to perform his work conveniently. The contractor is required to submit detail of materials measurement in material data sheet (MDS) for each of the segment as per the prescribed format Sheet-3 in this section of the tender document. The contractor shall assess quantity of each and every item of materials from the material data sheet. Small items such as binding wire, nails, binding tape etc. could be assessed on flat basis.
- 9.4 While submitting running bill the contractor must submit details of quantity of materials issued to him, quantity consumed as assessed from the material measurement sheet and quantity in his possession. Materials issued, used and in contractor's possession must be reconciled as per the prescribed format Sheet-3 in this section of the tender document. The materials in possession of the contractor shall be the opening material balance for the next running bill. The contractor shall also submit copies of store vouchers showing details of materials issued to him. Statement of materials submitted shall be checked and certified by the employer before payment of each of the running bill.
- 10. Workmanship and quality of work**
- 10.1 The contractor shall be attentive to maintain workmanship and quality of work while performing the work and shall obey to all the instructions of the field staff of the NEA time to time in this regard.
- 10.2 Special items such as concrete works, cable jointing works and transformer installation works etc. must be performed in presence of the NEA field staff. In case of the concrete works the NEA staff shall assess quantity of cement and steel to be used for each of the job and this must be followed for performing the job. Sand and aggregate must be supplied as per the standard specification of the tender document. The NEA field staff shall check quality of such materials and the contractor shall use the same after his approval. Curing of concrete works must be carried as per standard practice. The field staff shall have right to ask the contractor to repeat concrete works in case of his failure to execute the job as above or in his absence.
- 10.3 Each and every item of the standard data sheet (SDS) shall also be checked by the NEA staff for the satisfaction of quality of workmanship as per the prescribed specification of the tender document. In case of failure of the contractor to execute any item of the work as per proper workmanship or quality, the NEA shall have right to ask the contractor to revise or remedy such work at the cost of the contractor.

11. Commissioning of work

- 11.1 After completion of entire work of any village or load centre, the NEA after necessary tests shall arrange to electrically charge the same. In case of successful operation in satisfaction to the NEA the contractor shall be issued a provisional certificate starting from the date of such commissioning.
- 11.2 The NEA shall be authorized to change such date of commissioning in case of failure of the line due to any defect in the quality of construction.
- 11.3 Final acceptance of work shall be issued only after completion and satisfactory commissioning of whole work of the contract.

Section VII-E

DRAWINGS AND MATERIAL LISTS



A handwritten signature in black ink, appearing to be 'S. J. Singh'.

CONDUCTOR CLEARANCE

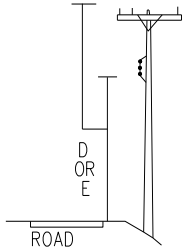
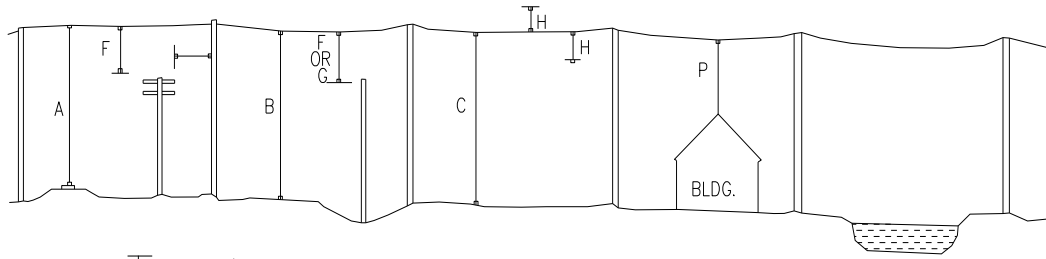

POLES ADJACENT TO ROADS

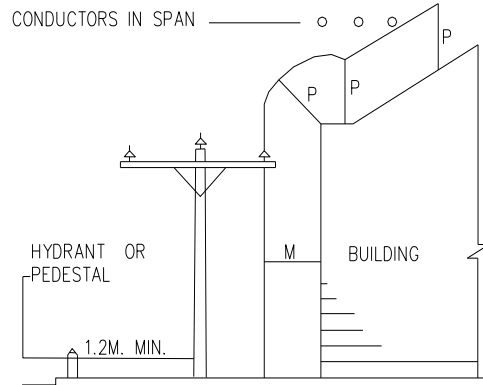

MINIMUM CLEARANCE FROM BUILDINGS

CROSSING OVER		VOLTAGE OF CIRCUIT CROSSING	METER
A	RAILROAD OR TURNPIKE	STAY & CABLE MESSENGER	7.10
		0 - 650 V.	7.10
		651 - 33,000 V.	7.60
B	ROAD, STREET, HIGHWAY OR LIMITED ACCESS HIGHWAY -	STAY & CABLE MESSENGER	5.80
		0 - 650 V.	5.80
		651 - 33,000 V.	6.10
C	AREAS ACCESSIBLE TO PEDESTRIANS ONLY	STAY & CABLE MESSENGER	4.60
		0 - 650 V.	4.60
		651 - 33,000	5.50
LINE ALONG SIDE OF			
D	MAIN HIGHWAYS STREETS OR ALLEYS	STAY & CABLE MESSENGER	5.50
		0 - 650 V.	5.50
		6581 - 33,000 V.	6.10
E	RURAL ROADS NO VEHICLE CROSSING UNDER	STAY & CABLE MESSENGER	4.60
		0 - 650 V.	4.60
		651 - 33,000 V.	6.00

LOCATION	VOLTAGE	CLEARANCE (METER)
M	0 - 11,000 V.	1.20
	11,000 - 33,000 V.	1.83
P	0 - 11,000 V.	2.44
	11,000 - 33,000 V.	3.65

CLEARANCE M ALSO SPECIFIED HORIZONTAL CLEARANCE FROM BALCONIES.

CSG-01

CONSTRUCTION STANDARDS
CONDUCTOR CLEARANCE

NEPAL ELECTRICITY AUTHORITY



[Signature]

CONDUCTORS AT LOWER LEVEL \ CONDUCTORS AT HIGHER LEVEL		SERVICE DROP 0 – 650 V	OPEN SUPPLY WIRES			STAYS AND SUPPLY CABLES ON GROUNDED MESSENGER
			0 – 650V	651 – 11000 V	33000 V	
F	COMMUNICATION WIRES	0.60 M.				
	COMMUNICATION CABLES AND MESSENGER	0.6 M. OVER 1.2 M. UNDER	1.38	2.15	—	0.60
G	SUPPLY CABLES ON EFFECTIVE GROUNDED MESSENGER	0.6 M. OVER 1.2 M. UNDER	0.60	0.60	—	0.60
H	OPEN SUPPLY WIRES 0 – 650 V. 651 – 11,000 V.	—	1.30	1.80	2.70	0.60
		—	—	1.20	—	1.20
GUYS SERVICE DROPS 0 – 650 V.		0.60	0.60	1.20	—	—

— VOLTAGE SHOWN ARE PHASE TO GROUND VALUES.

CSG-02	CONSTRUCTION STANDARDS CONDUCTOR CLEARANCE	NEPAL ELECTRICITY AUTHORITY
--------	---	-----------------------------

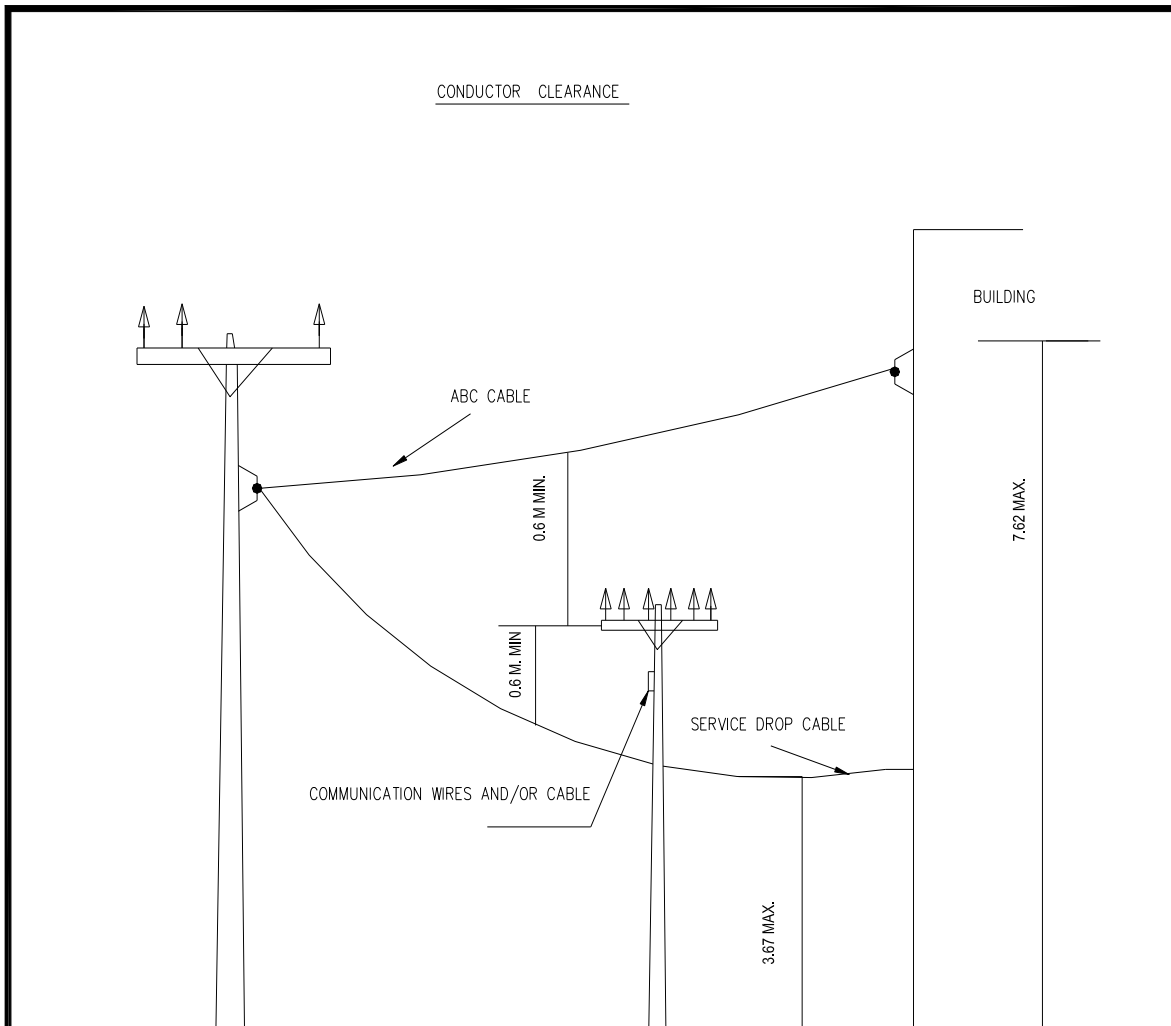







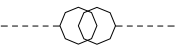
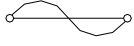
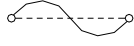
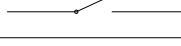
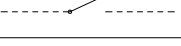
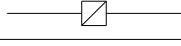
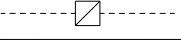
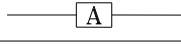
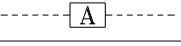

SERVICE DROP: Install Service over communication facilities where practical and attached to pole when available; otherwise cross under communication facilities; with proper clearance.

SERVICE DROP (0-600 V) Crossing Over	CLEARANCE
DRIVE WAY TO RESIDENCE, GARAGE, OR OVER PARKING LOT EXCLUDING TRACKS IN URBAN AREA	3.67 M
DRIVE WAY AND COMMERCIAL PARKING LOT OR AREA SUBJECT TO TRUCK TRAFFIC	4.57 M

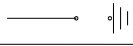
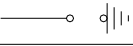
CSG-03

CONSTRUCTION STANDARDS
CONDUCTOR CLEARANCE

NEPAL ELECTRICITY AUTHORITY

SN	ELECTRIC SYMBOLS	EXISTING	PROPOSED
1	Transformer		
2	Fuse Cutout		
3	Disconnecting Switch		
4	Load Break Switch		
5	Auto Reclosure		
6	Substation		
7	Lighting Arrester		
8	Pole Telescopic with Stay		
9	Pole P.S.C. with Stay		
10	Tapping Point		

CSG-04

CONSTRUCTION STANDARDS
ELECTRICAL SYMBOLS

NEPAL ELECTRICITY AUTHORITY

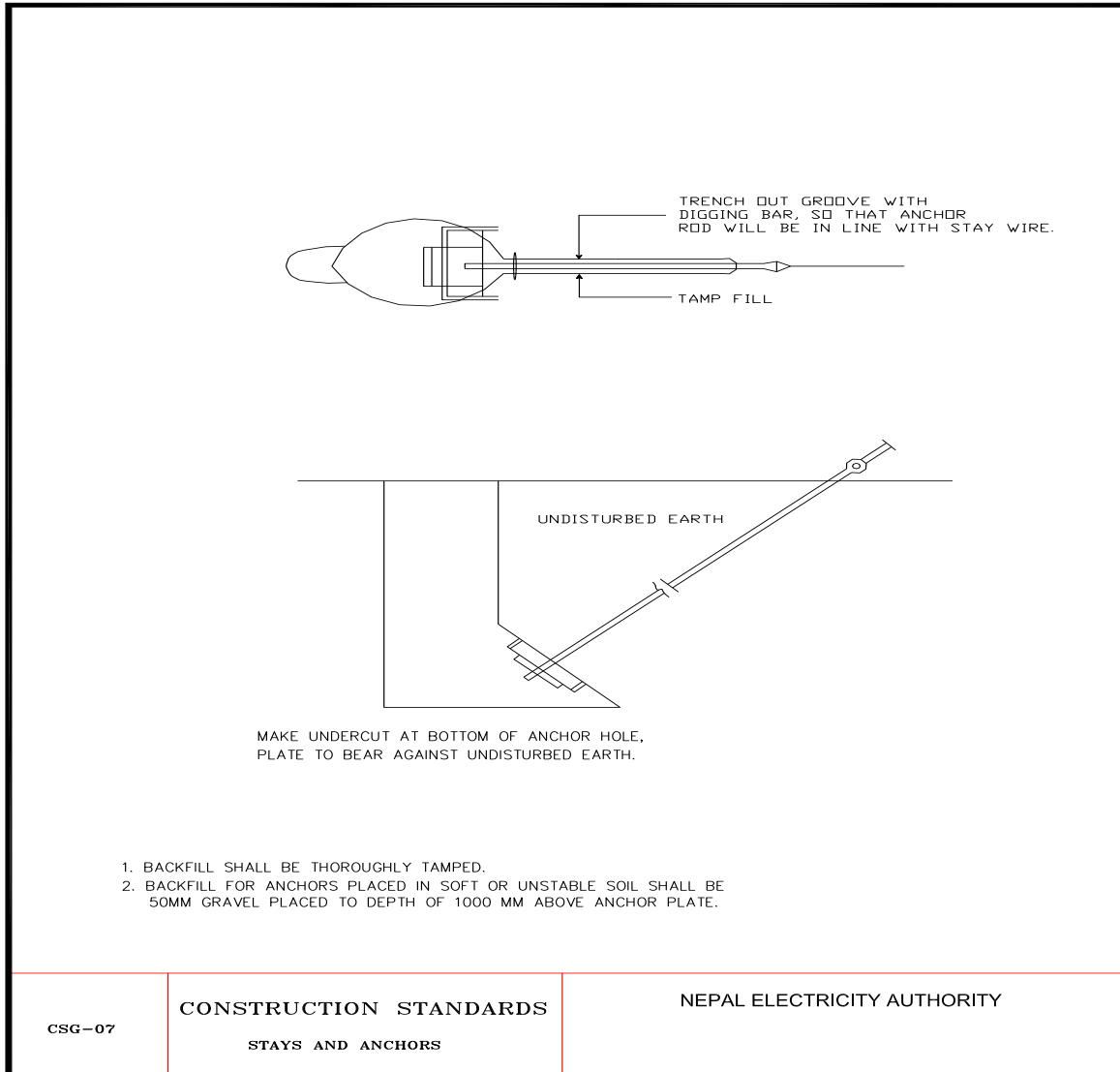

S.No.	MATERIAL (HT-STAY)	QTY.	UNIT	MATERIAL (LT-STAY)	QTY
1	HT STAY SET (600 x 600 MM PLATE AND ROD)	1	NOS	LT STAY SET (300 X 300 MM PLATE AND ROD)	1
2	HT TURN BUCKLE	1	NOS	LT TURN BUCKLE	1
3	HT THIMBLES	1	NOS	LT THIMBLES	1
4	POLE CLAMP(TC6)	1	NOS	POLE CLAMP(TC8)	0
5	HT STAY INSULATOR	1	NOS	STAY INSULATOR	1
6	PREFORM TIE FOR STAY WIRE 7/8 SWG	4	NOS	PREFORM TIE FOR STAY WIRE 7/12 SWG	4
7	7/8" SWG STAY WIRE	12	M	7/12" SWG STAY WIRE	10
8	HT EYE BOLT	0	NOS	LT EYE BOLT	0
CONSTRUCTION STANDARDS HT AND LT - SINGLE STAY			NEPAL ELECTRICITY AUTHORITY		

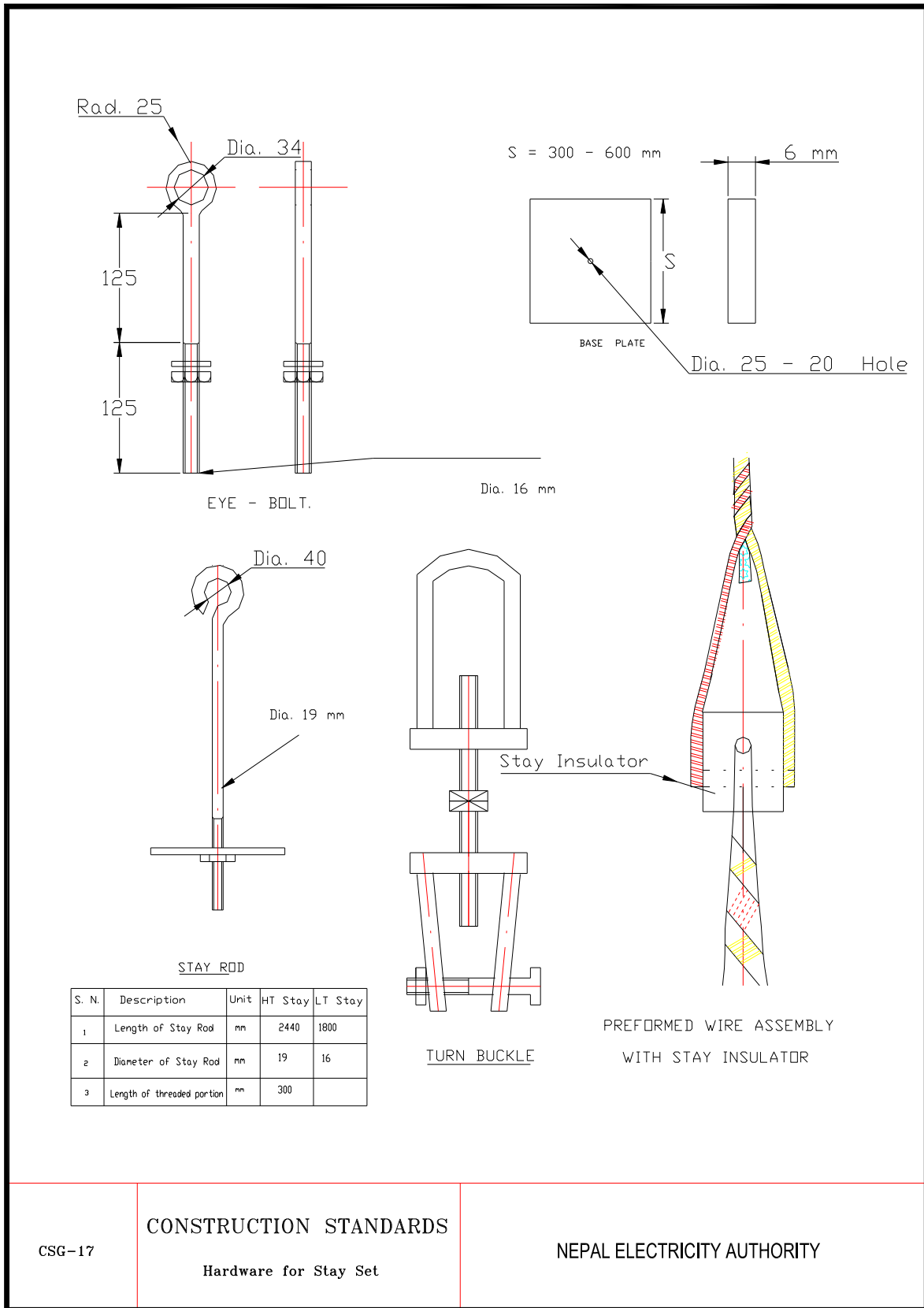

CSG-17

CONSTRUCTION STANDARDS

Hardware for Stay Set

NEPAL ELECTRICITY AUTHORITY

NOTES

- A. PLOT APPROXIMATE GROUND LINE PROFILE UNDER PROPOSED SAY.
- B. SELECT A POINT ON VERTICAL SCALE "V" CORRESPONDING TO GUY ATTACHMENT ON POLE, SELECT A POINT ON HORIZONTAL SCALE "L" CORRESPONDING TO SPECIFIED STAY LEAD. LAY A STRAIGHT EDGE SO THAT IT PASSES THROUGH THESE TWO POINTS.
- C. PROJECT POINT WHERE STRAIGHT EDGE INTERSECTS GROUND LINE PROFILE VERTICALLY TO HORIZONTAL SCALE "L" AND READ CORRECTED HORIZONTAL STAY LEAD.

EXAMPLE

V = 9M. ATTACHMENT ON POLE.
L = 7M. SPECIFIED GUY LEAD.

CORRECTED HORIZONTAL GUY LEAD:-
5.3M. - FOR GROUND ABOVE HORIZONTAL
11M. - FOR GROUND BELOW HORIZONTAL

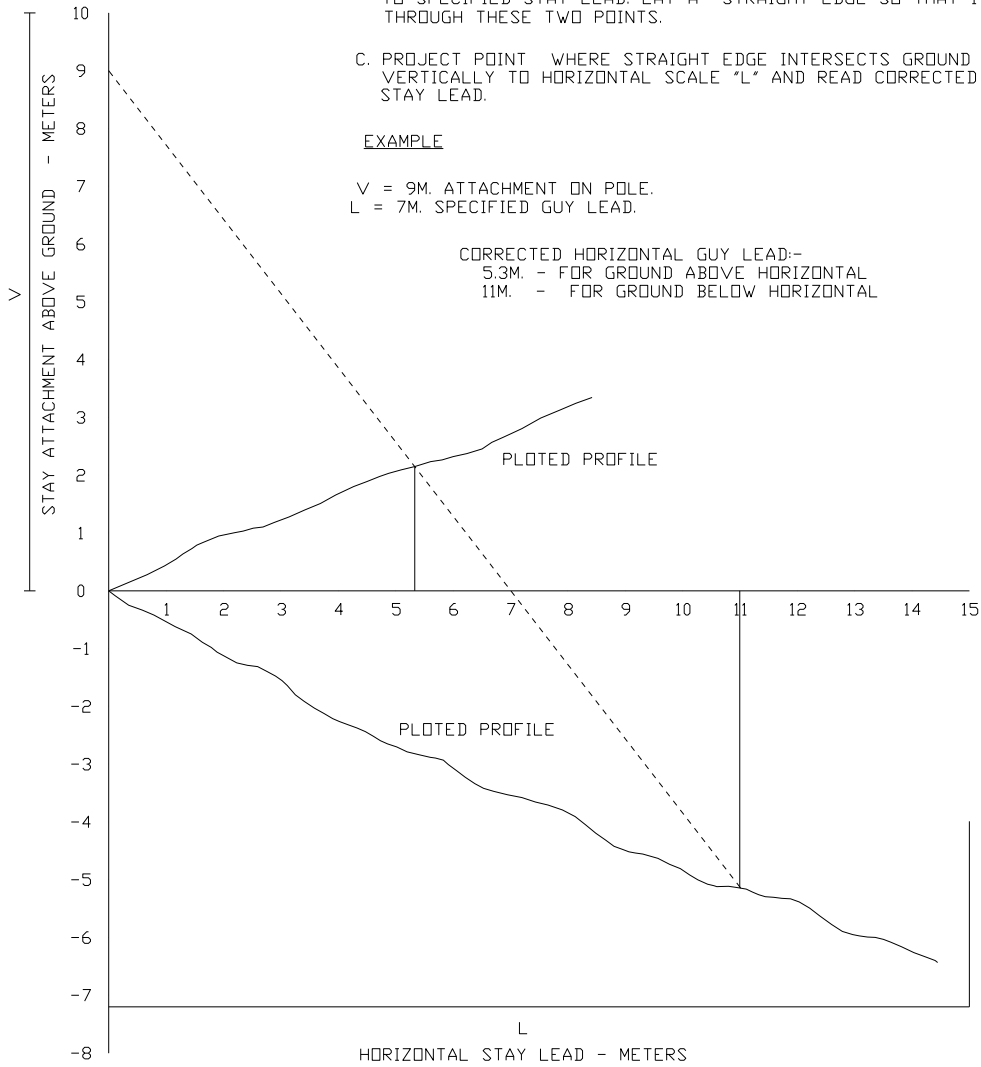

CSG-11	<p>CONSTRUCTION STANDARDS</p> <p>STAYS AND ANCHORS</p>	<p>NEPAL ELECTRICITY AUTHORITY</p>
--------	---	---

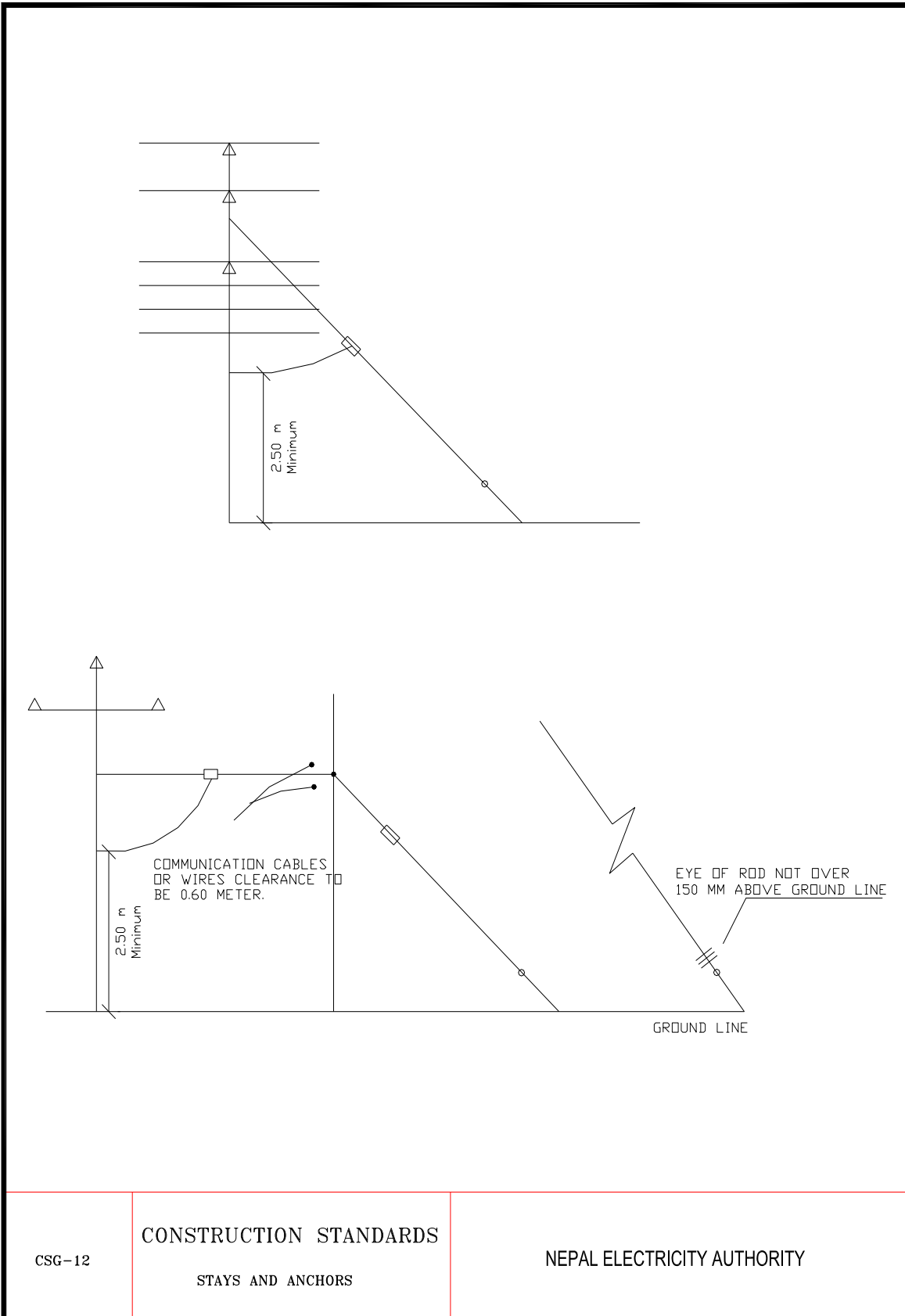

Signature

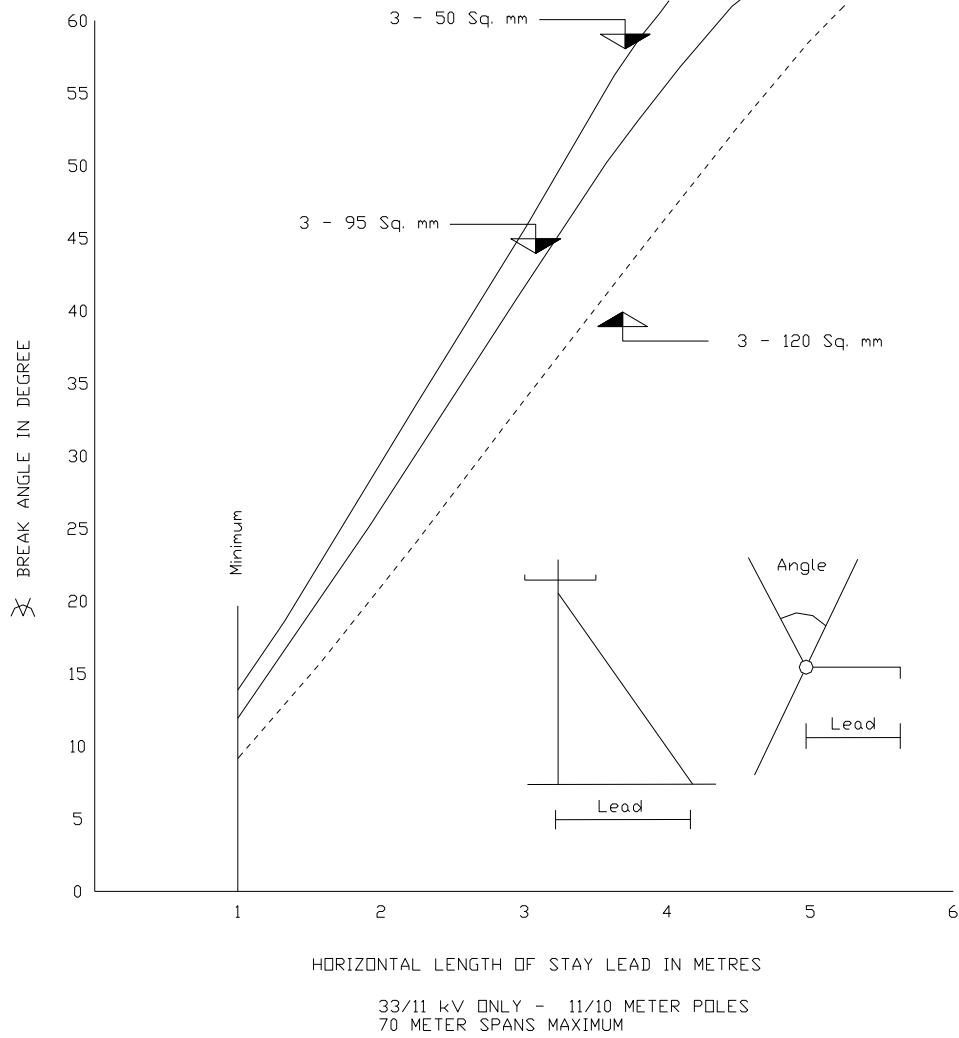

CSG-13

CONSTRUCTION STANDARDS
MINIMUM LEAD FOR SIDE ANGLE STAYS

NEPAL ELECTRICITY AUTHORITY

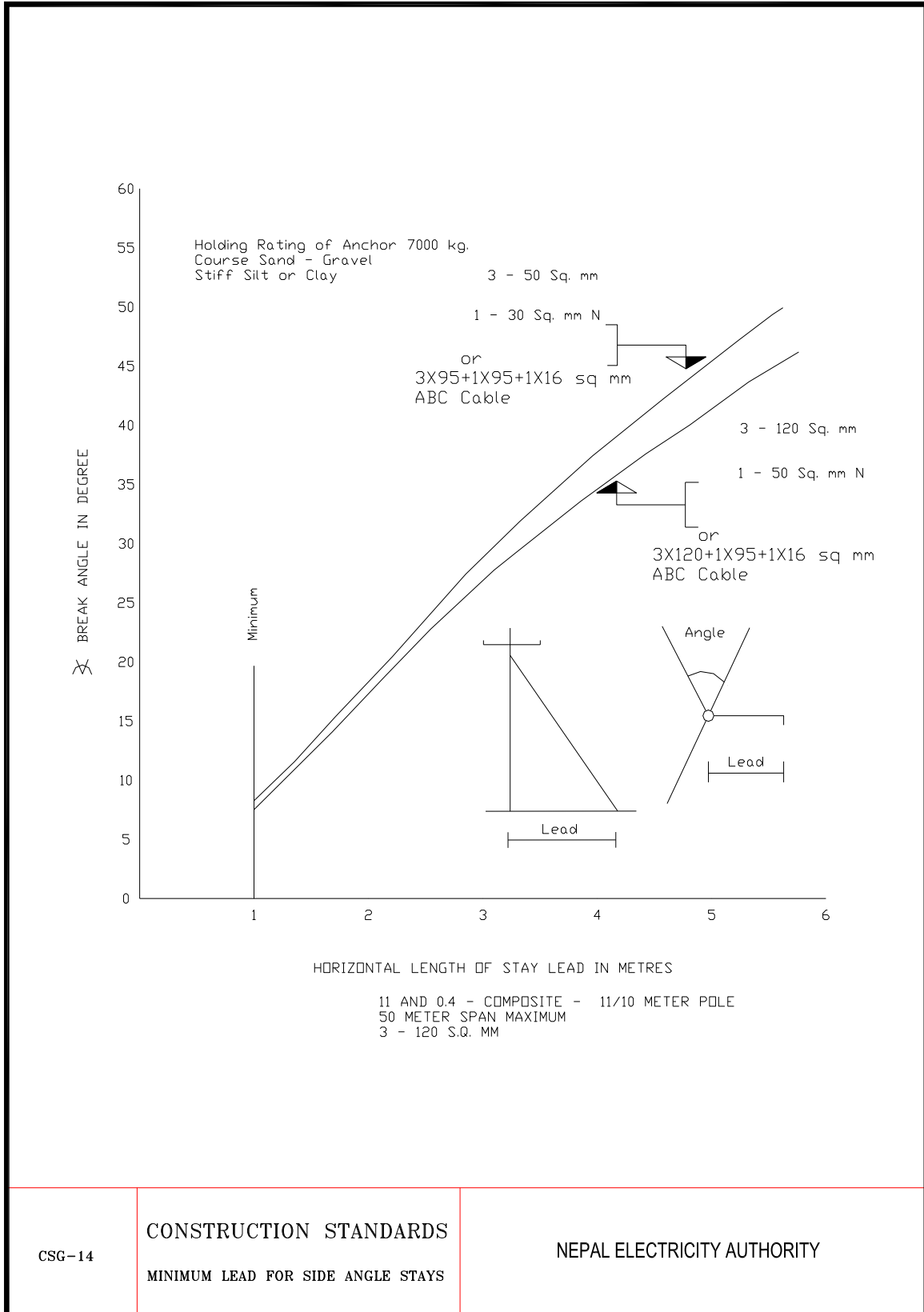

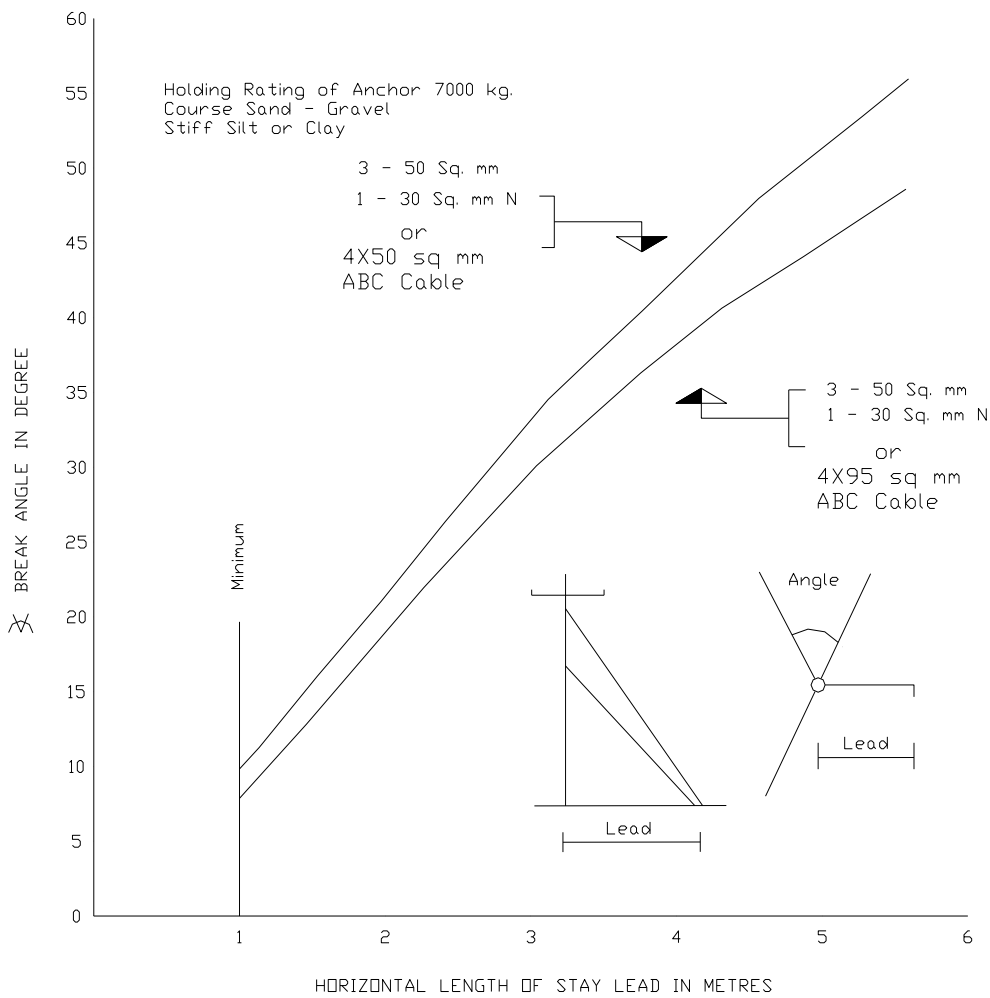

HORIZONTAL LENGTH OF STAY LEAD IN METRES

11 AND 0.4 kV -COMPOSITE - 11/10 METER POLE
50 METER SPAN MAXIMUM
3 - 50 S.Q. MM
1 - 30 S.Q. MM

CSG-15

CONSTRUCTION STANDARDS
MINIMUM LEAD FOR SIDE ANGLE STAYS

NEPAL ELECTRICITY AUTHORITY

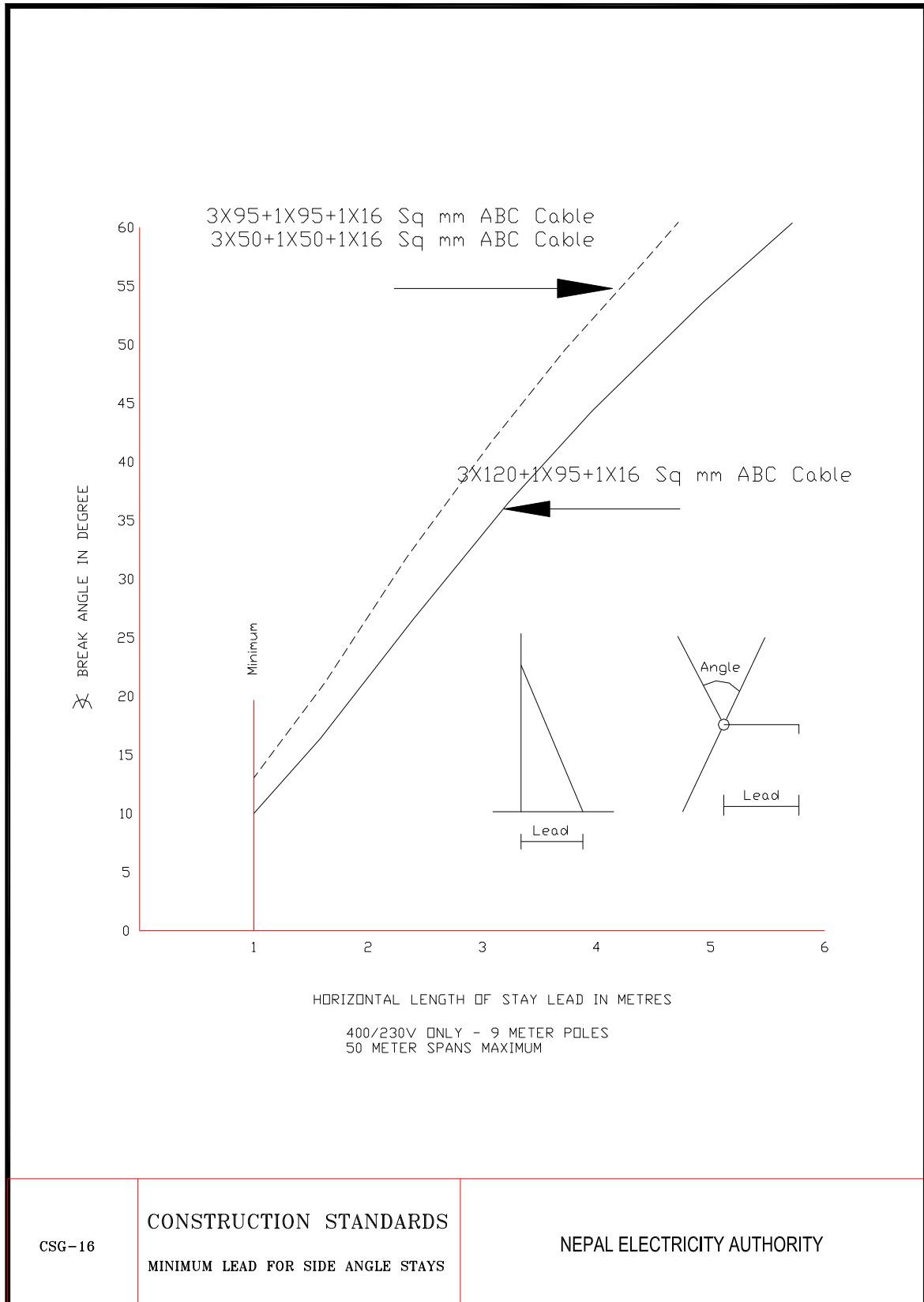

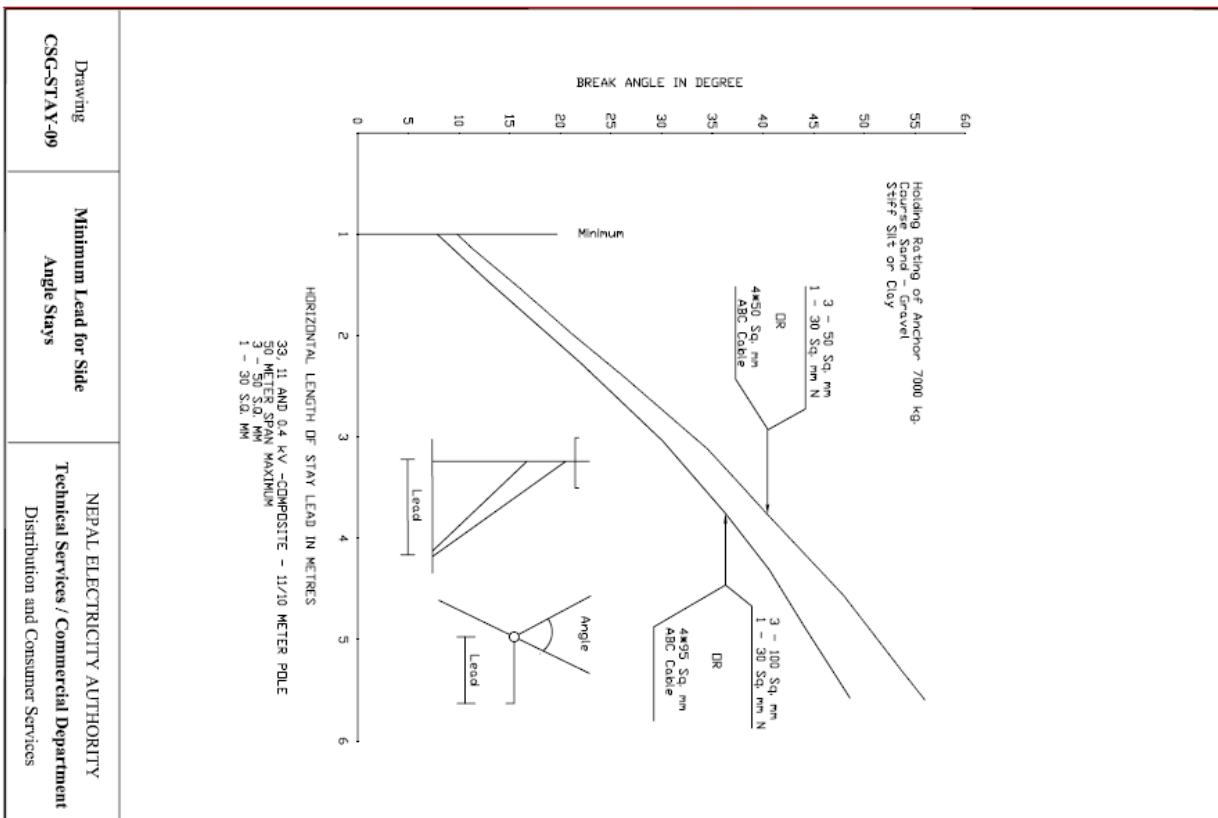
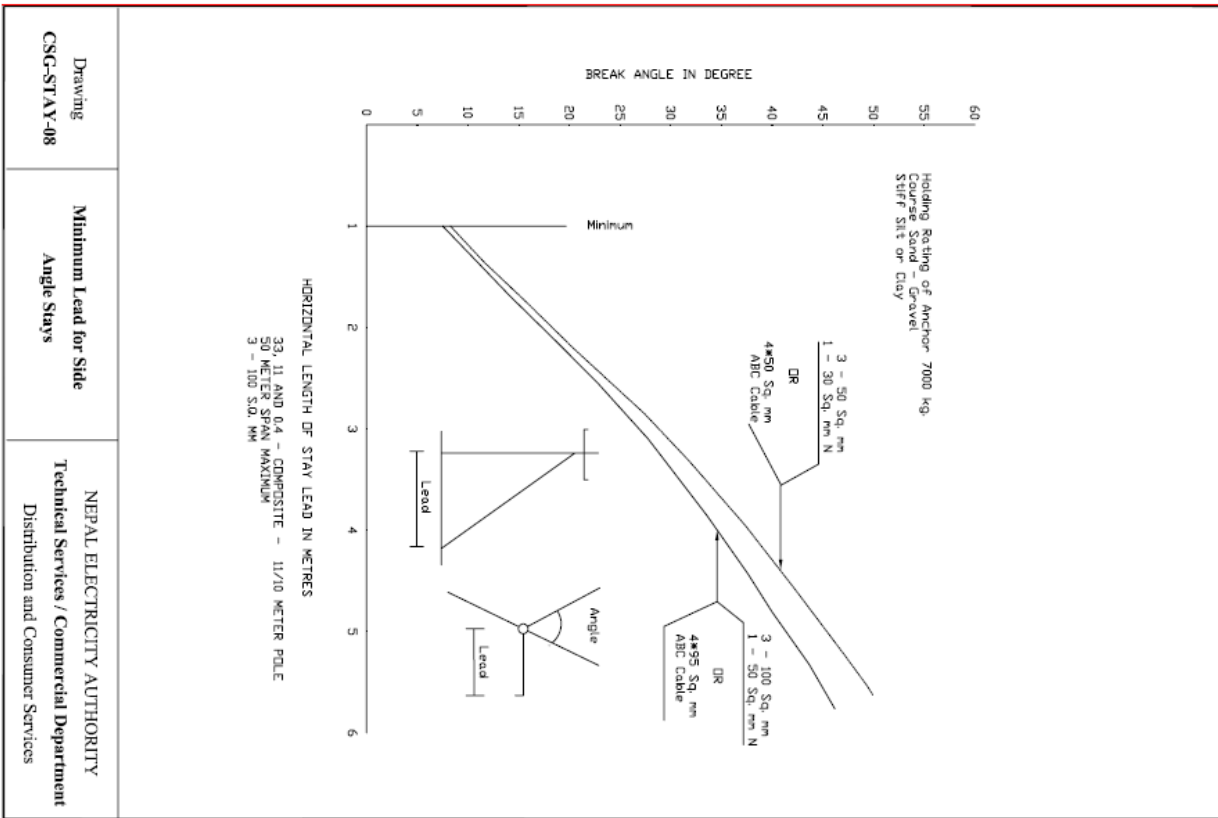

[Handwritten signature]

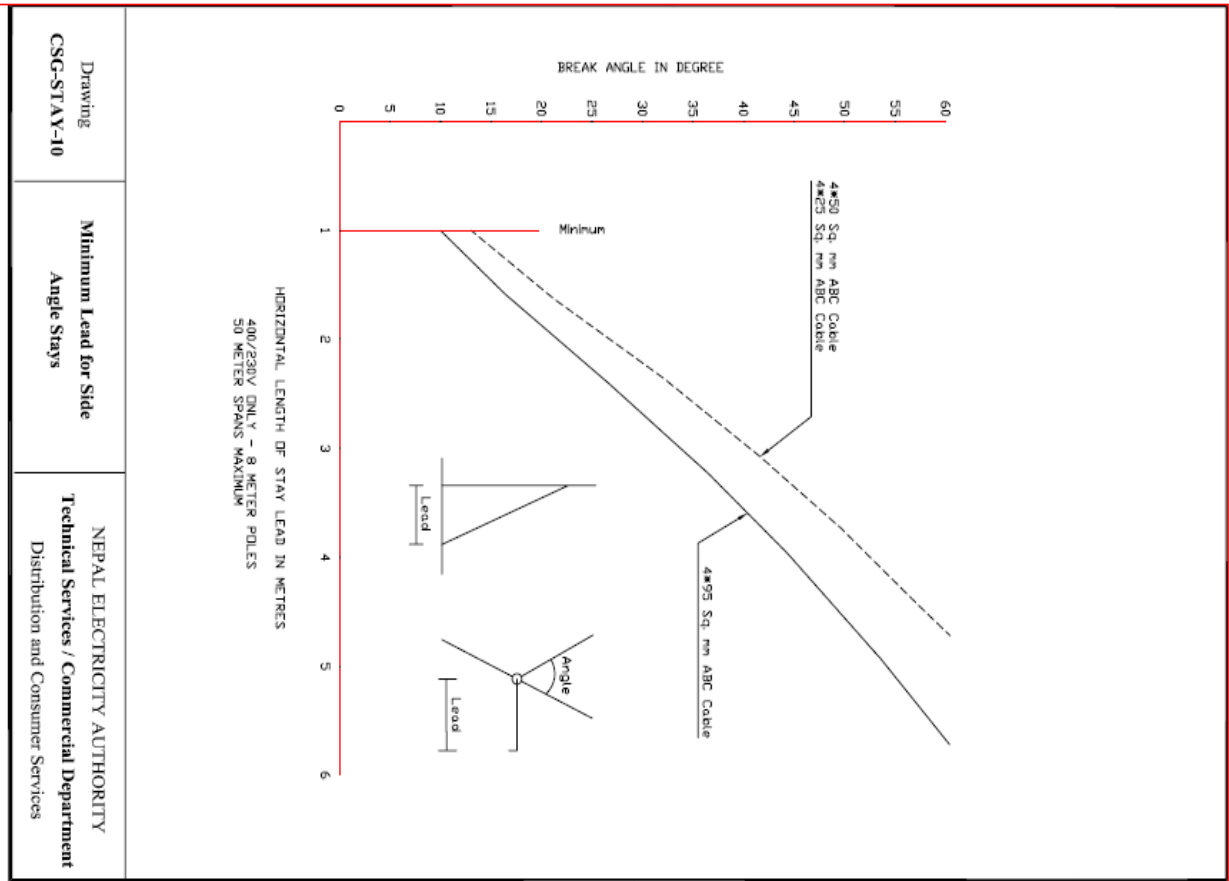

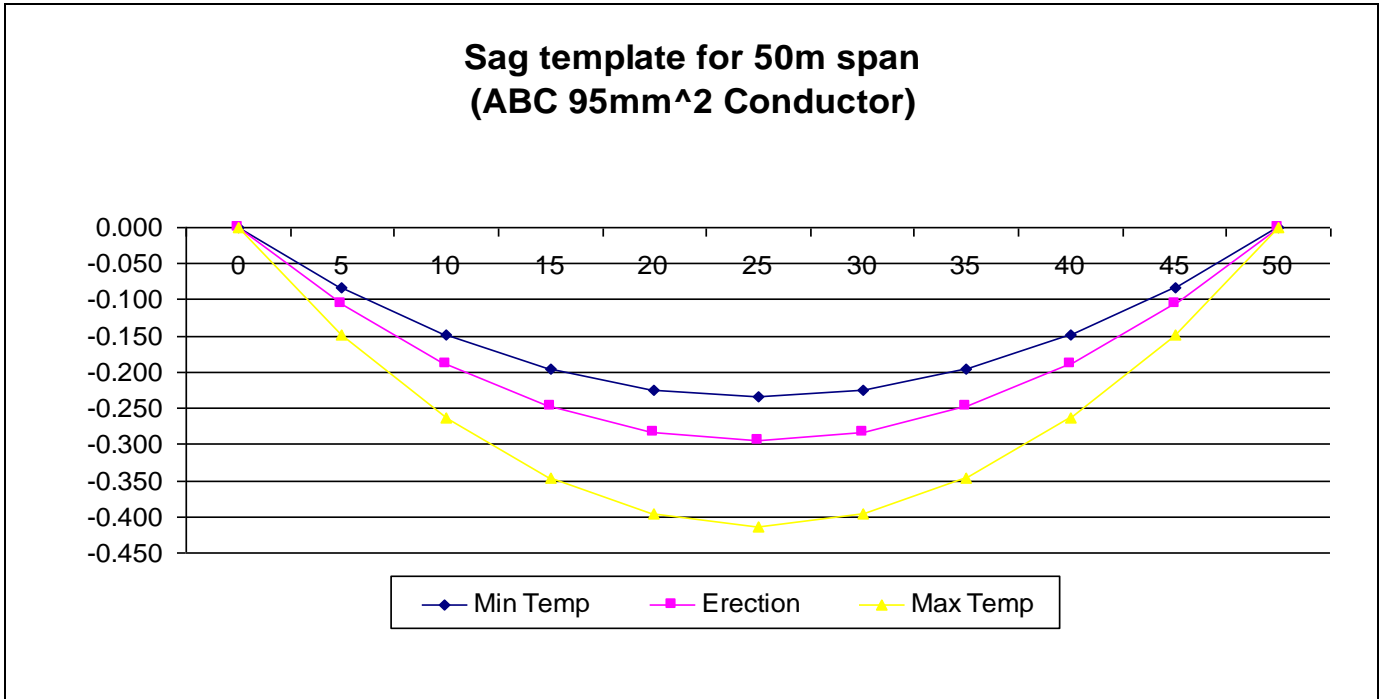

CSG-28	CONSTRUCTION STANDARDS ABC-SAG CHART 95 SQ MM	NEPAL ELECTRICITY AUTHORITY DISTRIBUTION SYSTEM REHABILITATION NEA
---------------	--	---

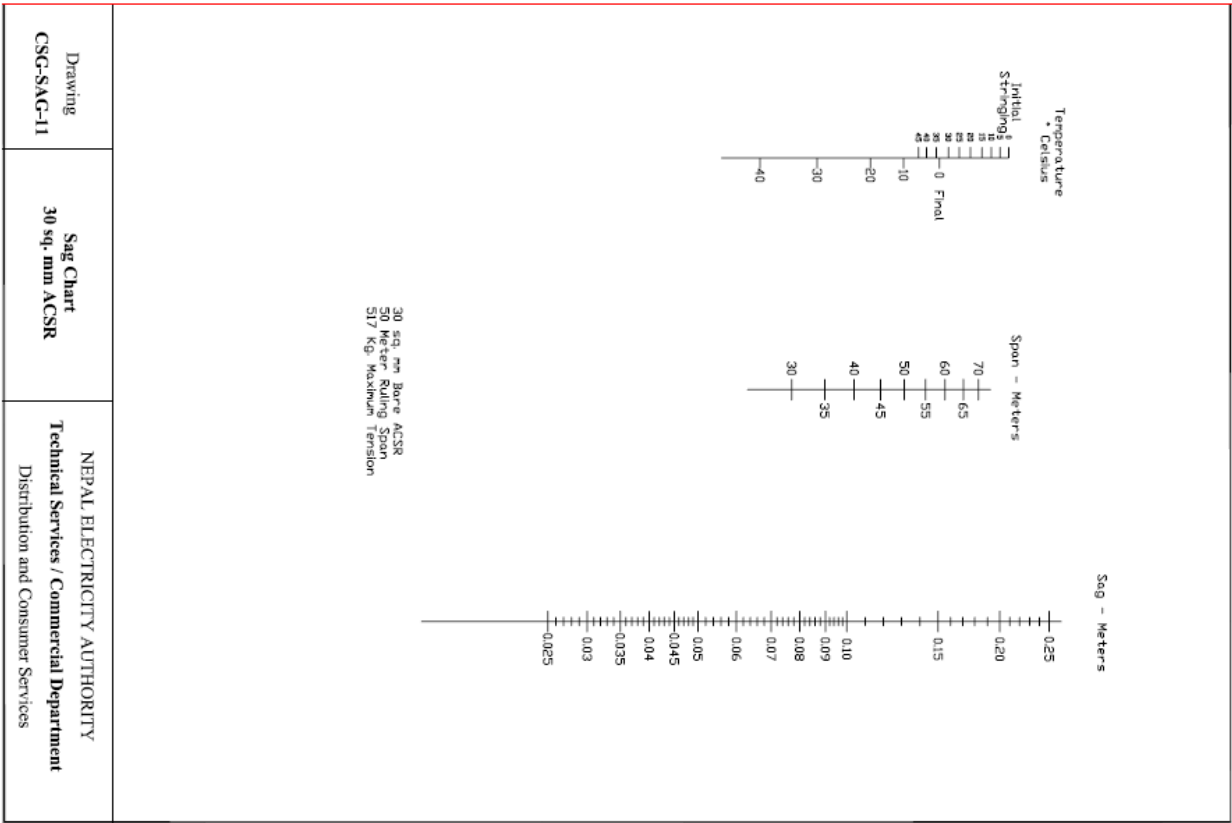

Drawing CSG-SAG-11	Sag Chart 30 sq. mm ACSR	NEPAL ELECTRICITY AUTHORITY Technical Services / Commercial Department Distribution and Consumer Services
-----------------------	-----------------------------	---

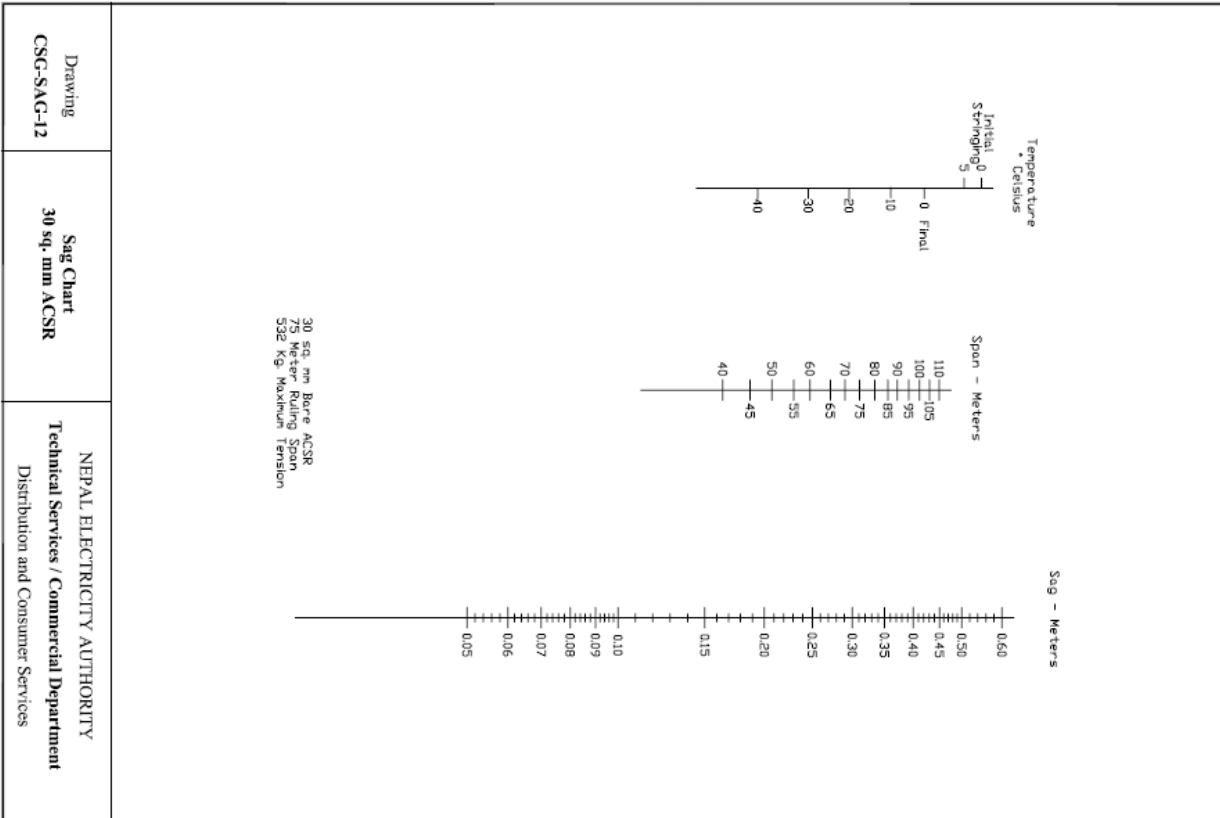

Drawing
CSG-SAG-12

Sag Chart
30 sq. mm ACSR

NEPAL ELECTRICITY AUTHORITY
Technical Services / Commercial Department
Distribution and Consumer Services

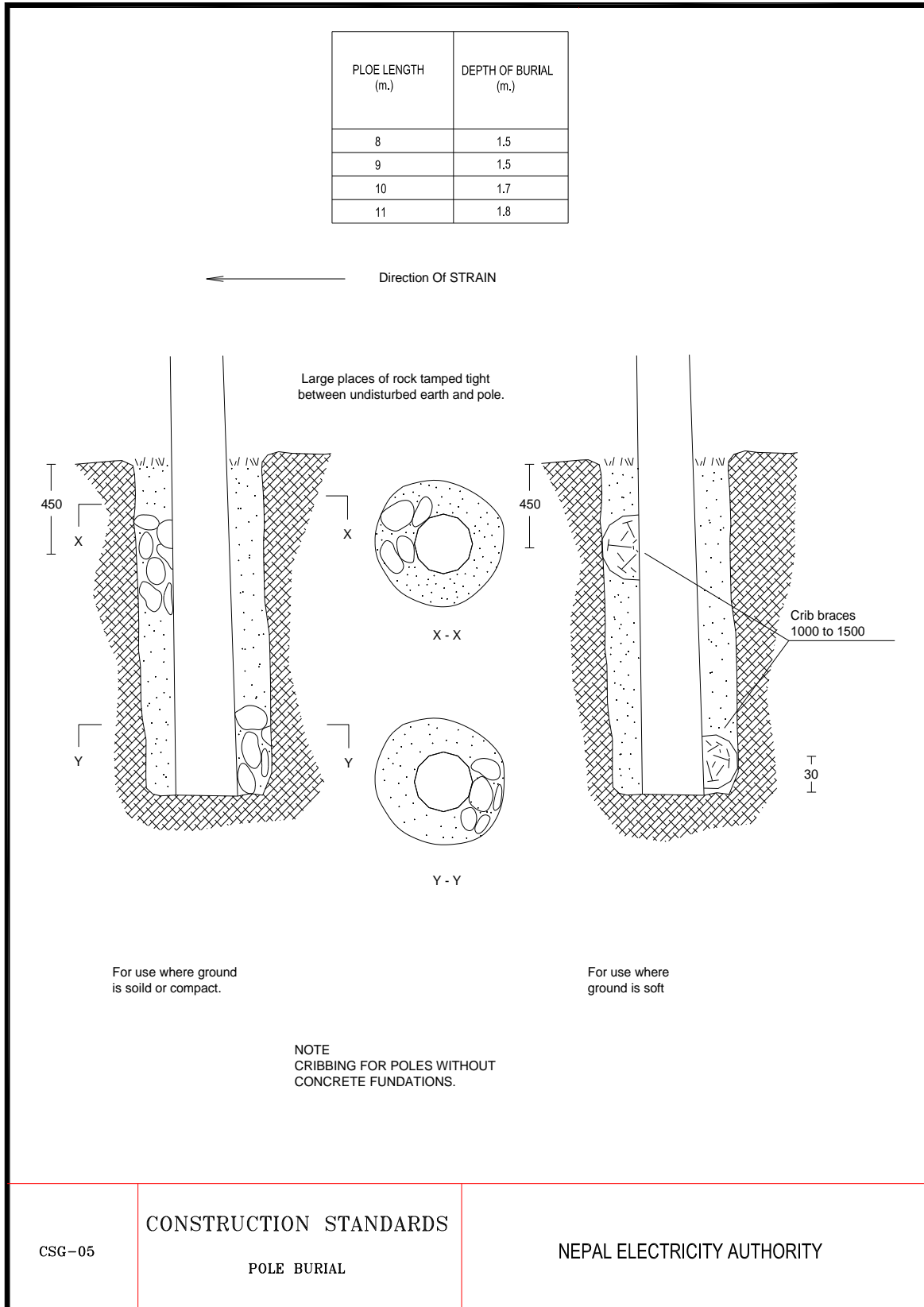

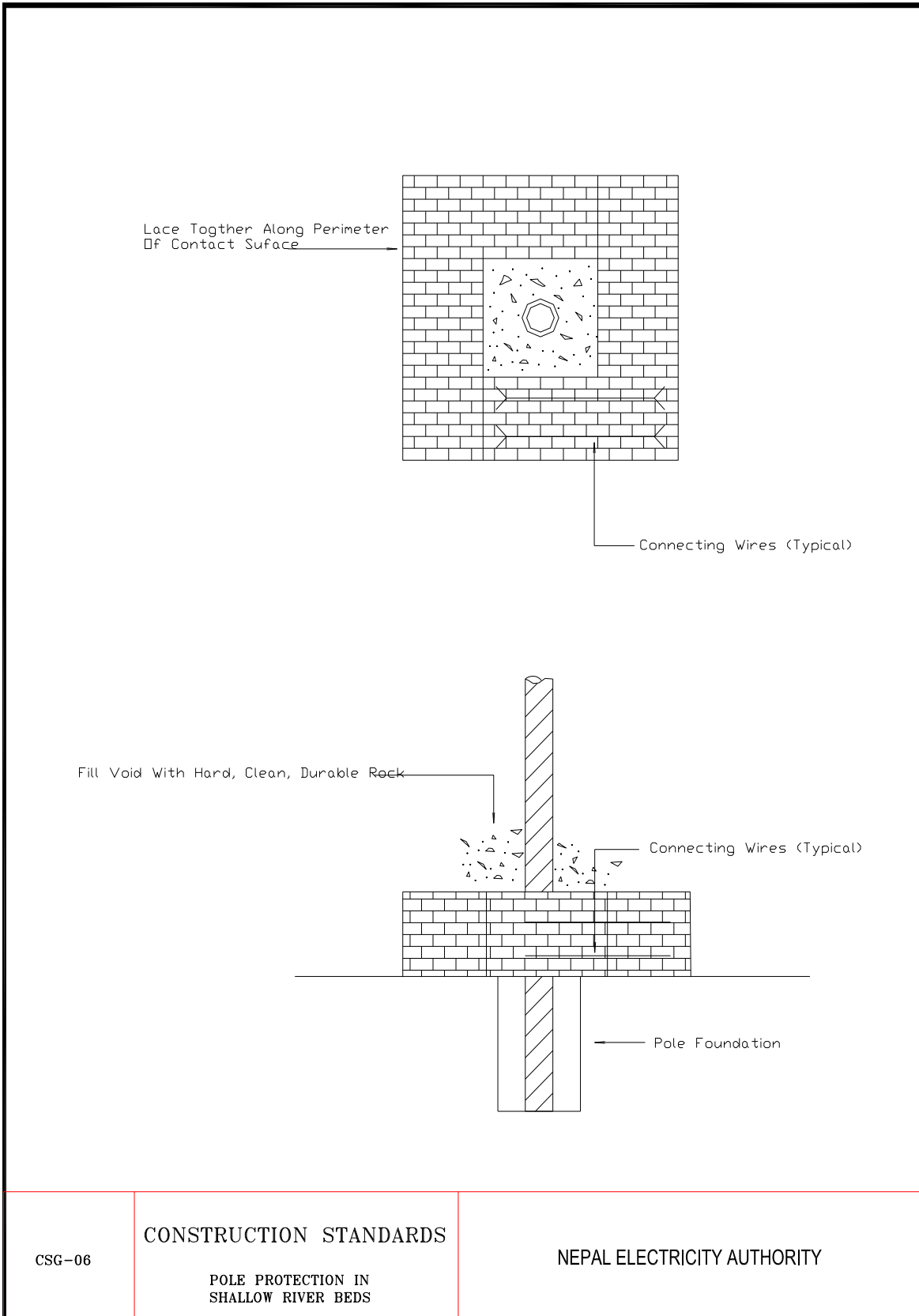

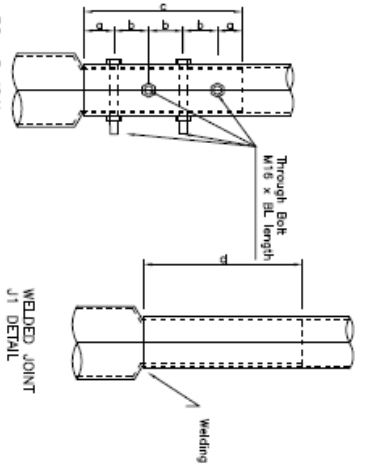
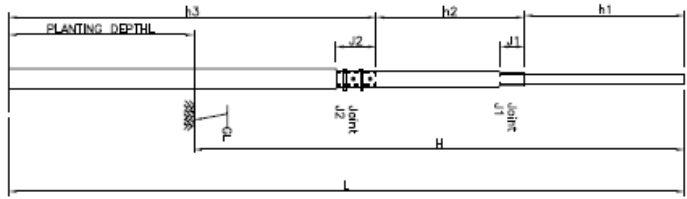

Pole type >>		B.W.
L	m	6
H	m	6.5
OD	mm	88.8
Thickness	mm	3.28
Top segment		
h1	m	1.76
OD	mm	114.3
Thickness	mm	3.05
Middle segment		
h2	m	1.75
OD	mm	130.2
Thickness	mm	4.5
Bottom Segment		
h3	m	4.3
WELDED JOINT		
Joint J1		
a	mm	250
b	mm	45
c	mm	70
d	mm	300
e	mm	190
Joint J2		
BL	mm	190
PLANTING DEPTH	m	1.5

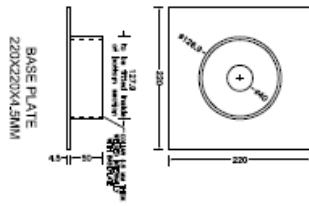

Note:-

1. All dimensions are in mm otherwise mentioned.
2. Drawings are not to scale.
3. Standards-
 - IS2713-1980- (Part I to II) Or Equivalent Specification (Tubular Poles for Overhead Power Lines)
 - IS 1161 -1998 Or Equivalent (Steel Tubes for Structural Purposes)
 - IS 2062-1992 Or Equivalent (Steel for General Structural Purposes)
 - IS 2629-1985 Or Equivalent (Standard for Hot Dip Galvanization)
4. Poles shall be hot dip galvanized inside as well as outside surface over the length specified in the specification. The remaining exposed outside portion shall be painted with red oxide painting in accordance with specification.

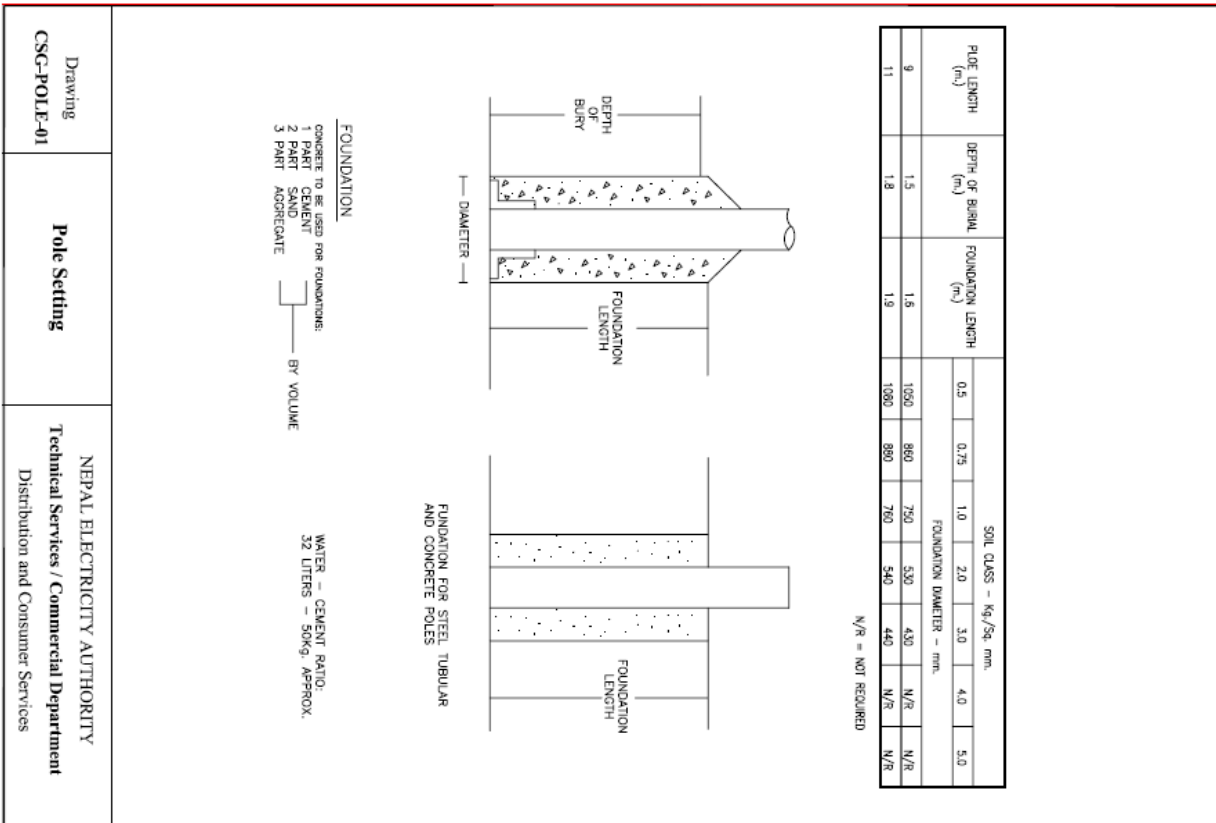

[Handwritten signature]

<p>Drawing CSI1-LM-07</p>	<p>Shackle Insulator</p>	<p>NEPAL ELECTRICITY AUTHORITY Technical Services / Commercial Department Distribution and Consumer Services</p>
<p style="text-align: center;">Shackle Insulator</p> <p style="text-align: center;">Applicable Standard IS : 1445</p>		

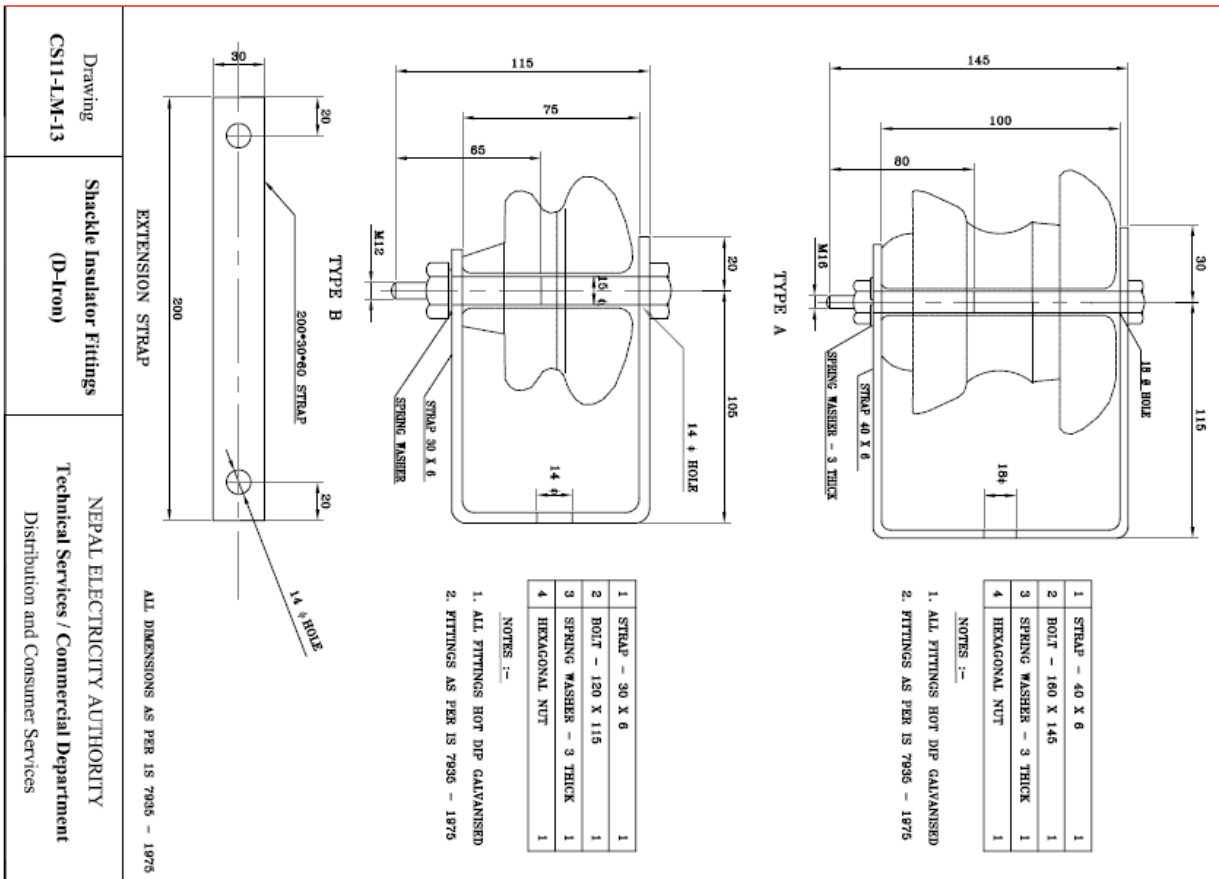

Drawing
CS11-LM-13

Shackle Insulator Fittings
(D-Iron)

NEPAL ELECTRICITY AUTHORITY
Technical Services / Commercial Department
Distribution and Consumer Services



[Handwritten signature]